

Construction Stormwater General Permit (CSWGP)

Stormwater Pollution Prevention Plan (SWPPP)

for

M-51 Industrial

Prepared for:

M-51 Industrial, LLC

Permittee / Owner	Developer	Operator / Contractor
M-51 Industrial, LLC P.O. Box 3884 Bellevue, WA 98009	M-51 Industrial LLC	TBD

16329 51st Ave NE, Marysville, WA 98271-7507

Certified Erosion and Sediment Control Lead (CESCL)

Name	Organization	Contact Phone Number
TBD	TBD	TBD

SWPPP Prepared By

Name	Organization	Contact Phone Number
Ryan Ferguson	LDC, Inc. 20210 142 nd Ave NE Woodinville, WA 98072	(425) 806-1869

SWPPP Preparation Date

01/05/2022

Project Construction Dates

Activity / Phase	Start Date	End Date
Mark Clearing Limits	May 2022	May 2023
Install TESC Measures	May 2022	May 2023
Install Stabilized Construction Entrance	May 2022	May 2023
Begin Clearing and Grubbing	May 2022	May 2023
Stabilize Soils	June 2022	May 2023
Protect Slopes	June 2022	May 2023
Stabilized Site	June 2022	May 2023

Contents

Project Information (1.0).....	5
Existing Conditions (1.1).....	5
Proposed Construction Activities (1.2).....	6
Construction Stormwater Best Management Practices (BMPs) (2.0).....	7
The 13 Elements (2.1).....	7
Element 1: Preserve Vegetation / Mark Clearing Limits (2.1.1).....	7
Element 2: Establish Construction Access (2.1.2).....	8
Element 3: Control Flow Rates (2.1.3).....	9
Element 4: Install Sediment Controls (2.1.4).....	10
Element 5: Stabilize Soils (2.1.5).....	11
Element 6: Protect Slopes (2.1.6).....	12
Element 7: Protect Drain Inlets (2.1.7).....	13
Element 8: Stabilize Channels and Outlets (2.1.8).....	14
Element 9: Control Pollutants (2.1.9).....	15
Element 10: Control Dewatering (2.1.10).....	18
Element 11: Maintain BMPs (2.1.11).....	19
Element 12: Manage the Project (2.1.12).....	20
Element 13: Protect Low Impact Development (LID) BMPs (2.1.13).....	23
Pollution Prevention Team (3.0).....	24
Monitoring and Sampling Requirements (4.0).....	25
Site Inspection (4.1).....	25
Stormwater Quality Sampling (4.2).....	25
Turbidity Sampling (4.2.1).....	25
pH Sampling (4.2.2).....	27
Discharges to 303(d) or Total Maximum Daily Load (TMDL) Waterbodies (5.0).....	28
303(d) Listed Waterbodies (5.1).....	28
TMDL Waterbodies (5.2).....	28
Reporting and Record Keeping (6.0).....	29
Record Keeping (6.1).....	29
Site Log Book (6.1.1).....	29
Records Retention (6.1.2).....	29
Updating the SWPPP (6.1.3).....	29
Reporting (6.2).....	30
Discharge Monitoring Reports (6.2.1).....	30
Notification of Noncompliance (6.2.2).....	30
Appendix/Glossary.....	32
Site Map.....	32
BMP Detail.....	33
Correspondence.....	35
Site Inspection Form.....	36
Construction Stormwater General Permit (CSWGP).....	43

303(d) List Waterbodies / TMDL Waterbodies Information	44
Contaminated Site Information	45
Engineering Calculations	46

List of Acronyms and Abbreviations

Acronym / Abbreviation	Explanation
303(d)	Section of the Clean Water Act pertaining to Impaired Waterbodies
BFO	Bellingham Field Office of the Department of Ecology
BMP(s)	Best Management Practice(s)
CESCL	Certified Erosion and Sediment Control Lead
CO₂	Carbon Dioxide
CRO	Central Regional Office of the Department of Ecology
CSWGP	Construction Stormwater General Permit
CWA	Clean Water Act
DMR	Discharge Monitoring Report
DO	Dissolved Oxygen
Ecology	Washington State Department of Ecology
EPA	United States Environmental Protection Agency
ERO	Eastern Regional Office of the Department of Ecology
ERTS	Environmental Report Tracking System
ESC	Erosion and Sediment Control
GULD	General Use Level Designation
NPDES	National Pollutant Discharge Elimination System
NTU	Nephelometric Turbidity Units
NWRO	Northwest Regional Office of the Department of Ecology
pH	Power of Hydrogen
RCW	Revised Code of Washington
SPCC	Spill Prevention, Control, and Countermeasure
su	Standard Units
SWMMEW	Stormwater Management Manual for Eastern Washington
SWMMWW	Stormwater Management Manual for Western Washington
SWPPP	Stormwater Pollution Prevention Plan
TESC	Temporary Erosion and Sediment Control
SWRO	Southwest Regional Office of the Department of Ecology
TMDL	Total Maximum Daily Load
VFO	Vancouver Field Office of the Department of Ecology
WAC	Washington Administrative Code
WSDOT	Washington Department of Transportation
WWHM	Western Washington Hydrology Model

Project Information (1.0)

Project/Site Name: M-51 Industrial Site

Street/Location: 16329 51st Ave NE

City: Marysville **State:** Washington **Zip Code:** 98271

Subdivision: N/A

Receiving Waterbody: N/A

Existing Conditions (1.1)

Total acreage (including support activities such as off-site equipment staging yards, material storage areas, borrow areas).

Total acreage: 71.38 AC

Disturbed acreage: 71.38 AC

Existing structures: The site contains one single story house, three large barns, several sheds and a swimming pool.

Landscape topography: The site has slopes from 0-6% slopes southwestward.

Existing Vegetation: Farmland with a few mature trees around the existing structures.

Critical Areas (wetlands, streams, high erosion risk, steep or difficult to stabilize slopes):

There are no critical areas on site. A man made irrigation ditch borders the eastern edge of the site. This irrigation ditch outlets into the Middle Fork Quilceda Creek approximately 1.5 miles downstream of the site.

List of known impairments for 303(d) listed or Total Maximum Daily Load (TMDL) for the receiving waterbody: No known impairment for the receiving body.

Table 1 includes a list of suspected and/or known contaminants associated with the construction activity.

Table 1 – Summary of Site Pollutant Constituents

Constituent (Pollutant)	Location	Depth	Concentration

Proposed Construction Activities (1.2)

Description of site development (example: subdivision):

The M-51 Industrial Site proposes the early clearing and grading associated to the development of an industrial building.

Description of construction activities (example: site preparation, demolition, excavation):

Construction activities include demolition of all existing structures, excavation and removal of existing impervious surfaces, and inhaul of fill.

Description of site drainage including flow from and onto adjacent properties. Must be consistent with Site Map in Appendix A:

A ditch is located along the eastern boundary of the site, therefore no upstream flows enter the site. Flows onsite will be collected or sheet flow into one of the permanent detention ponds.

Description of final stabilization (example: extent of revegetation, paving, landscaping):

Final stabilization of the project site will be conducted using BMPs listed in Section 2.0 of this report. All landscaped areas will be underlain with BMP T5.13 soil mixtures in the developed condition.

Contaminated Site Information

Proposed activities regarding contaminated soils or groundwater (example: on-site treatment system, authorized sanitary sewer discharge):

No contamination control measures are necessary due to the existing condition of the project site.

Construction Stormwater Best Management Practices (BMPs) (2.0)

The SWPPP is a living document reflecting current conditions and changes throughout the life of the project. These changes may be informal (i.e. hand-written notes and deletions). Update the SWPPP when the CESCL has noted a deficiency in BMPs or deviation from original design.

The 13 Elements (2.1)

Element 1: Preserve Vegetation / Mark Clearing Limits (2.1.1)

To protect adjacent properties and to reduce the area of soil exposed to construction, the limits of construction will be clearly marked before land-disturbing activities begin. Trees that are to be preserved, as well as all sensitive areas and their buffers, shall be clearly delineated, both in the field and on the plans. In general, natural vegetation and native topsoil shall be retained in an undisturbed state to the maximum extent possible. The BMPs relevant to marking the clearing limits that will be applied for this project include:

- High Visibility or Metal Plastic Fence (BMP C103)
- Silt Fence (BMP C233)

Clearing limits shall be marked in the initial stages of construction in order to establish the correct boundary for clearing and grubbing. Alternate BMPs for marking clearing limits are included in Appendix B as a quick reference tool for the onsite inspector in the event the BMP(s) listed above are deemed ineffective or inappropriate during construction to satisfy the requirements set forth in the General NPDES Permit (Appendix D). To avoid potential erosion and sediment control issues that may cause a violation(s) of the NPDES Construction Stormwater permit (as provided in Appendix D), the Certified Erosion and Sediment Control Lead will promptly initiate the implementation of one or more of the alternative BMPs listed in Appendix B after the first sign that existing BMPs are ineffective or failing.

Element 2: Establish Construction Access (2.1.2)

Construction access or activities occurring on unpaved areas shall be minimized, yet where necessary, access points shall be stabilized to minimize the tracking of sediment onto public roads, and wheel washing, street sweeping, and street cleaning shall be employed to prevent sediment from entering state waters. A vacuum street sweeper truck will be used to clean the road. All wash wastewater shall be controlled on site. The specific BMPs related to establishing construction access that will be used on this project include:

- Stabilized Construction Access (BMP C105)

Element 3: Control Flow Rates (2.1.3)

Will you construct stormwater retention and/or detention facilities?

Yes, a detention pond

Will you use permanent infiltration ponds or other low impact development (example: rain gardens, bio-retention, porous pavement) to control flow during construction?

No

- Temporary Sediment Pond (BMP C241)

Temporary sediment ponds will serve as flow control on the site in the initial stages of the project. As fill is compacted onsite and the shaping of the permanent detention ponds is done, the detention ponds may begin to serve as TESC ponds. The temporary sediment ponds will be pumped to discharge locations per the erosion control plans. Sediment will be removed from the detention pond prior to the completion of construction.

TESC measures shall be implemented in the initial stages of construction once clearing limits are established and construction entrances are installed. In general, discharge rates of stormwater from the site will be controlled where increases in impervious area or soil compaction during construction could lead to downstream erosion, or where necessary to meet local agency stormwater discharge requirements (e.g. discharge to combined sewer systems).

Element 4: Install Sediment Controls (2.1.4)

All stormwater runoff from disturbed areas shall pass through an appropriate sediment removal BMP before leaving the construction site. The specific BMPs to be used for controlling sediment on this project include:

- Silt Fence (BMP C233)
- Interceptor Dike and Swale (BMP C200)
- Temporary Sediment Pond (BMP C241)

Alternate sediment control BMPs are included in Appendix B as a quick reference tool for the onsite inspector in the event the BMP(s) listed above are deemed ineffective or inappropriate during construction to satisfy the requirements set forth in the General NPDES Permit (Appendix D). To avoid potential erosion and sediment control issues that may cause a violation(s) of the NPDES Construction Stormwater permit (as provided in Appendix D), the Certified Erosion and Sediment Control Lead will promptly initiate the implementation of one or more of the alternative BMPs listed in Appendix B after the first sign that existing BMPs are ineffective or failing.

In addition, sediment will be removed from paved areas in and adjacent to construction work areas manually or using mechanical sweepers, as needed, to minimize tracking of sediments on vehicle tires away from the site and to minimize washoff of sediments from adjacent streets in runoff.

Element 5: Stabilize Soils (2.1.5)

West of the Cascade Mountains Crest

Season	Dates	Number of Days Soils Can be Left Exposed
During the Dry Season	May 1 – September 30	7 days
During the Wet Season	October 1 – April 30	2 days

Soils must be stabilized at the end of the shift before a holiday or weekend if needed based on the weather forecast.

Anticipated Start date: TBD

Anticipated End date: TBD

Will you construct during the wet season?

TBD

Exposed and unworked soils shall be stabilized with the application of effective BMPs to prevent erosion throughout the life of the project. The specific BMPs for soil stabilization that shall be used on this project include:

- Temporary and Permanent Seeding (BMP C120)
- Mulching (BMP C121)
- Plastic Covering (BMP C123)

The project site is located west of the Cascade Mountain Crest. As such, no soils shall remain exposed and unworked for more than 7 days during the dry season (May 1 to September 30) and 2 days during the wet season (October 1 to April 30). Regardless of the time of year, all soils shall be stabilized at the end of the shift before a holiday or weekend if needed based on weather forecasts.

In general, cut and fill slopes will be stabilized as soon as possible and soil stockpiles will be temporarily covered with plastic sheeting. All stockpiled soils shall be stabilized from erosion, protected with sediment trapping measures, and where possible, be located away from storm drain inlets, waterways, and drainage channels.

Element 6: Protect Slopes (2.1.6)

Will steep slopes be present at the site during construction?

No

All cut and fill slopes will be designed, constructed, and protected in a manner than minimizes erosion. The following specific BMPs will be used to protect slopes for this project:

- Temporary and Permanent Seeding (BMP C120)
- Mulching (BMP C121)
- Plastic Covering (BMP C123)

Erosion will be minimized by designing and constructing cut-and-fill slopes in a manner where continuous length of slope will be reduced with diversions and roughening slope surfaces. Stormwater runoff will be diverted away from slopes and disturbed areas with interceptor dikes, pipes, and swales. Check dams will be installed every 100' or 2' of elevation change along constructed channels in order to reduce flow velocity and erosion. Excavated material shall be placed on the uphill side of trenches, consistent with safety and space considerations.

Element 7: Protect Drain Inlets (2.1.7)

All storm drain inlets and culverts made operable during construction shall be protected to prevent unfiltered or untreated water from entering the drainage conveyance system. However, the first priority is to keep all access roads clean of sediment and keep street wash water separate from entering storm drains until treatment can be provided. Inlet protection will be implemented for all drainage inlets and culverts that could potentially be impacted by sediment-laden runoff on and near the project site. No inlets are proposed for the project that require protection.

Element 8: Stabilize Channels and Outlets (2.1.8)

Provide stabilization, including armoring material, adequate to prevent erosion of outlets, adjacent stream banks, slopes, and downstream reaches, will be installed at the outlets of all conveyance systems.

Where site runoff is to be conveyed in channels, or discharged to a stream or some other natural drainage point, efforts will be taken to prevent downstream erosion. The specific BMPs for channel and outlet stabilization that shall be used on this project include:

- Grass Lined Channels (BMP C201)
- Check Dams (C207)

Element 9: Control Pollutants (2.1.9)

The following pollutants are anticipated to be present on-site:

Table 2 – Pollutants

Pollutant (and source, if applicable)

All pollutants, including waste materials and demolition debris, that occur onsite shall be handled and disposed of in a manner that does not cause contamination of stormwater. Good housekeeping and preventative measures will be taken to ensure that the site will be kept clean, well-organized, and free of debris. If required, BMPs to be implemented to control specific sources of pollutants are discussed below.

Vehicles, construction equipment, and/or petroleum product storage/dispensing:

- All vehicles, equipment, and petroleum product storage/dispensing areas will be inspected regularly to detect any leaks or spills, and to identify maintenance needs to prevent leaks or spills.

- On-site fueling tanks and petroleum product storage containers shall include secondary containment.

- Spill prevention measures, such as drip pans, will be used when conducting maintenance and repair of vehicles or equipment.

- In order to perform emergency repairs on site, temporary plastic will be placed beneath and, if raining, over the vehicle.

- Contaminated surfaces shall be cleaned immediately following any discharge or spill incident.

Concrete and grout:

- Process water and slurry resulting from concrete work will be prevented from entering the waters of the State by implementing Concrete Handling measures (BMP C151). Concrete wash out areas shall not be allowed on bare dirt or allowed to drain to bare dirt or the storm system.
- Saw cutting and Surfacing Pollution Prevention (BMP C152)

The facility does require a Spill Prevention, Control, and Countermeasure (SPCC) Plan under the Federal regulations of the Clean Water Act (CWA) and will be provided under separate cover.

Will maintenance, fueling, and/or repair of heavy equipment and vehicles occur on-site?

No

Emergency repairs are very unlikely but possible. In order to perform emergency repairs on site, temporary plastic will be placed beneath and, if raining, over the vehicle.

Will wheel wash or tire bath system BMPs be used during construction?

Yes

All sediment will be removed from paved areas in and adjacent to construction work areas manually or using mechanical sweepers, as needed, to minimize tracking of sediments on vehicle tires away from the site and to minimize washoff of sediments from adjacent streets in runoff. A wheel wash or tire bath system will be installed during the course of construction.

Will pH-modifying sources be present on-site?

No

Table 3 – pH-Modifying Sources

	None
	Bulk cement
	Cement kiln dust
	Fly ash
	Other cementitious materials
	New concrete washing or curing waters
	Waste streams generated from concrete grinding and sawing
	Exposed aggregate processes
	Dewatering concrete vaults
	Concrete pumping and mixer washout waters

	Recycled concrete
	Other (i.e. calcium lignosulfate) [please describe]

Concrete trucks must not be washed out onto the ground, or into storm drains, open ditches, streets, or streams. Excess concrete must not be dumped on-site, except in designated concrete washout areas with appropriate BMPs installed.

Element 10: Control Dewatering (2.1.10)

There will be no dewatering as part of this construction project. All dewatering water from open cut excavation, tunneling, foundation work, trench, or underground vaults shall be discharged into a controlled conveyance system prior to discharge to a sediment trap or sediment pond, or will be treated with dispersion across vegetated areas or by other modular methods before being discharged to or draining to an uncontrolled collection and conveyance system. Channels will be stabilized, per Element #8. Clean, non-turbid dewatering water will not be routed through stormwater sediment ponds, and will be discharged to systems tributary to the receiving waters of the State in a manner that does not cause erosion, flooding, or a violation of State water quality standards in the receiving water. Highly turbid dewatering water from soils known or suspected to be contaminated, or from use of construction equipment, will require additional monitoring and treatment as required for the specific pollutants based on the receiving waters into which the discharge is occurring. Such monitoring is the responsibility of the contractor.

However, the dewatering of soils known to be free of contamination will trigger BMPs to trap sediment and reduce turbidity. At a minimum, geotextile fabric socks/bags/cells will be used to filter this material. Other BMPs to be used for sediment trapping and turbidity reduction include the following:

- Concrete Handling (BMP C151)
- Use of a sedimentation bag, with outfall to a ditch or swale for small volumes of localized dewatering.

Alternative BMP not included in the above bulleted list are included in Appendix B as a quick reference tool for the onsite inspector in the event the BMP(s) listed above are deemed ineffective or inappropriate during construction to satisfy the requirements set forth in the General NPDES Permit (Appendix D). To avoid potential erosion and sediment control issues that may cause a violation(s) of the NPDES Construction Stormwater permit (as provided in Appendix D), the Certified Erosion and Sediment Control Lead will promptly initiate the implementation of one or more of the alternative BMPs listed in Appendix B after the first sign that existing BMPs are ineffective or failing.

Table 4 – Dewatering BMPs

	Infiltration
	Transport off-site in a vehicle (vacuum truck for legal disposal)
	Ecology-approved on-site chemical treatment or other suitable treatment technologies
	Sanitary or combined sewer discharge with local sewer district approval (last resort)
	Use of sedimentation bag with discharge to ditch or swale (small volumes of localized dewatering)

Element 11: Maintain BMPs (2.1.11)

All temporary and permanent Erosion and Sediment Control (ESC) BMPs shall be maintained and repaired as needed to ensure continued performance of their intended function.

Maintenance and repair shall be conducted in accordance with each particular BMP specification (see *Volume II of the SWMMWW* or *Chapter 7 of the SWMMEW*).

Visual monitoring of all BMPs installed at the site will be conducted at least once every calendar week and within 24 hours of any stormwater or non-stormwater discharge from the site. If the site becomes inactive and is temporarily stabilized, the inspection frequency may be reduced to once every calendar month.

All temporary ESC BMPs shall be removed within 30 days after final site stabilization is achieved or after the temporary BMPs are no longer needed.

Trapped sediment shall be stabilized on-site or removed. Disturbed soil resulting from removal of either BMPs or vegetation shall be permanently stabilized.

Additionally, protection must be provided for all BMPs installed for the permanent control of stormwater from sediment and compaction. BMPs that are to remain in place following completion of construction shall be examined and restored to full operating condition. If sediment enters these BMPs during construction, the sediment shall be removed and the facility shall be returned to conditions specified in the construction documents.

Element 12: Manage the Project (2.1.12)

The project will be managed based on the following principles:

- Projects will be phased to the maximum extent practicable and seasonal work limitations will be taken into account.
- Inspection and monitoring:
 - Inspection, maintenance and repair of all BMPs will occur as needed to ensure performance of their intended function.
 - Site inspections and monitoring will be conducted in accordance with Special Condition S4 of the CSWGP. Sampling locations are indicated on the Site Map. Sampling station(s) are located in accordance with applicable requirements of the CSWGP.
- Maintain an updated SWPPP.
 - The SWPPP will be updated, maintained, and implemented in accordance with Special Conditions S3, S4, and S9 of the CSWGP.

As site work progresses the SWPPP will be modified routinely to reflect changing site conditions. The SWPPP will be reviewed monthly to ensure the content is current.

Table 5 – Management

x	Design the project to fit the existing topography, soils, and drainage patterns
x	Emphasize erosion control rather than sediment control
x	Minimize the extent and duration of the area exposed
x	Keep runoff velocities low
x	Retain sediment on-site
x	Thoroughly monitor site and maintain all ESC measures
x	Schedule major earthwork during the dry season
	Other (please describe)

Reference Elements 1-11 above for BMP implementation.

Table 6 – BMP Implementation Schedule

Phase of Construction Project	Stormwater BMPs	Date	Wet/Dry Season

Element 13: Protect Low Impact Development (LID) BMPs (2.1.13)

Low impact development (LID) BMPs are NOT proposed for use on this project. However, should LID BMPs be proposed ,the BMPs stated in Elements #1 through #12 shall be used to protect LID BMPs.

Pollution Prevention Team (3.0)

Table 7 – Team Information

Title	Name(s)	Phone Number
Certified Erosion and Sediment Control Lead (CESCL)	TBD	TBD
Resident Engineer	Joe Hopper, PE	(425) 806-1869
Emergency Ecology Contact	Miya Spratt	(360) 870-7853
Emergency Permittee/ Owner Contact	John Sandstrom	(425) 765-5888
Non-Emergency Owner Contact	John Sandstrom	(425) 765-5888
Monitoring Personnel	TBD	TBD
Ecology Regional Office	Northwest Region	(425) 649-7000

Monitoring and Sampling Requirements (4.0)

Monitoring includes visual inspection, sampling for water quality parameters of concern, and documentation of the inspection and sampling findings in a site log book. A site log book will be maintained for all on-site construction activities and will include:

- A record of the implementation of the SWPPP and other permit requirements
- Site inspections
- Stormwater sampling data

The site log book must be maintained on-site within reasonable access to the site and be made available upon request to Ecology or the local jurisdiction.

Numeric effluent limits may be required for certain discharges to 303(d) listed waterbodies. See CSWGP Special Condition S8 and Section 5 of this template.

Complete the following paragraph for sites that discharge to impaired waterbodies for fine sediment, turbidity, phosphorus, or pH:

The receiving waterbody, Sammish, is impaired for: Biotic Integrity. All stormwater and dewatering discharges from the site are subject to an **effluent limit** of 8.5 su for pH or 25 NTU for turbidity. However the receiving body is not within a quartermile of the project.

Site Inspection (4.1)

Site inspections will be conducted at least once every calendar week and within 24 hours following any discharge from the site. For sites that are temporarily stabilized and inactive, the required frequency is reduced to once per calendar month.

The discharge point(s) are indicated on the Site Map (see Appendix A) and in accordance with the applicable requirements of the CSWGP.

Reference Appendix D for a Site Inspection Form.

Stormwater Quality Sampling (4.2)

Turbidity Sampling (4.2.1)

Requirements include calibrated turbidity meter or transparency tube to sample site discharges for compliance with the CSWGP. Sampling will be conducted at all discharge points at least once per calendar week.

Method for sampling turbidity:

Table 8 – Turbidity Sampling Method

X	Turbidity Meter/Turbidimeter (required for disturbances 5 acres or greater in size)
	Transparency Tube (option for disturbances less than 1 acre and up to 5 acres in size)

The benchmark for turbidity value is 25 nephelometric turbidity units (NTU) and a transparency less than 33 centimeters.

If the discharge's turbidity is 26 to 249 NTU or the transparency is less than 33 cm but equal to or greater than 6 cm, the following steps will be conducted:

1. Review the SWPPP for compliance with Special Condition S9. Make appropriate revisions within 7 days of the date the discharge exceeded the benchmark.
2. Immediately begin the process to fully implement and maintain appropriate source control and/or treatment BMPs as soon as possible. Address the problems within 10 days of the date the discharge exceeded the benchmark. If installation of necessary treatment BMPs is not feasible within 10 days, Ecology may approve additional time when the Permittee requests an extension within the initial 10-day response period.
3. Document BMP implementation and maintenance in the site log book.

If the turbidity exceeds 250 NTU or the transparency is 6 cm or less at any time, the following steps will be conducted:

1. Telephone or submit an electronic report to the applicable Ecology Region's Environmental Report Tracking System (ERTS) within 24 hours.
<https://www.ecology.wa.gov/About-us/Get-involved/Report-an-environmental-issue>
 - Central Region (Benton, Chelan, Douglas, Kittitas, Klickitat, Okanogan, Yakima): (509) 575-2490
 - Eastern Region (Adams, Asotin, Columbia, Ferry, Franklin, Garfield, Grant, Lincoln, Pend Oreille, Spokane, Stevens, Walla Walla, Whitman): (509) 329-3400
 - Northwest Region (King, Kitsap, Island, San Juan, Skagit, Snohomish, Whatcom): (425) 649-7000
 - Southwest Region (Clallam, Clark, Cowlitz, Grays Harbor, Jefferson, Lewis, Mason, Pacific, Pierce, Skamania, Thurston, Wahkiakum,): (360) 407-6300
2. Immediately begin the process to fully implement and maintain appropriate source control and/or treatment BMPs as soon as possible. Address the problems within 10 days of the date the discharge exceeded the benchmark. If installation of necessary treatment BMPs is not feasible within 10 days, Ecology may approve additional time when the Permittee requests an extension within the initial 10-day response period
3. Document BMP implementation and maintenance in the site log book.
4. Continue to sample discharges daily until one of the following is true:
 - Turbidity is 25 NTU (or lower).
 - Transparency is 33 cm (or greater).
 - Compliance with the water quality limit for turbidity is achieved.
 - 1 - 5 NTU over background turbidity, if background is less than 50 NTU
 - 1% - 10% over background turbidity, if background is 50 NTU or greater
 - The discharge stops or is eliminated.

pH Sampling (4.2.2)

pH monitoring is required for “Significant concrete work” (i.e. greater than 1000 cubic yards poured concrete or recycled concrete over the life of the project). The use of engineered soils (soil amendments including but not limited to Portland cement-treated base [CTB], cement kiln dust [CKD] or fly ash) also requires pH monitoring.

For significant concrete work, pH sampling will start the first day concrete is poured and continue until it is cured, typically three (3) weeks after the last pour.

For engineered soils and recycled concrete, pH sampling begins when engineered soils or recycled concrete are first exposed to precipitation and continues until the area is fully stabilized.

Stormwater samples will be collected daily from all points of discharge from the site and measure for pH using a calibrated pH meter, pH test kit, or wide range pH indicator paper.

If the measured pH is 8.5 or greater, the following measures will be taken:

1. Prevent high pH water from entering storm sewer systems or surface water.
2. Adjust or neutralize the high pH water to the range of 6.5 to 8.5 su using appropriate technology such as carbon dioxide (CO₂) sparging (liquid or dry ice).
3. Written approval will be obtained from Ecology prior to the use of chemical treatment other than CO₂ sparging or dry ice.

Method for sampling pH:

Table 8 – pH Sampling Method

	pH meter
	pH test kit
	Wide range pH indicator paper

Discharges to 303(d) or Total Maximum Daily Load (TMDL) Waterbodies (5.0)

303(d) Listed Waterbodies (5.1)

Is the receiving water 303(d) (Category 5) listed for turbidity, fine sediment, phosphorus, or pH?

No. There is not a receiving waterbody within ½ mile of the site.

List the impairment(s):

N/A

The receiving waterbody, Samamish , is impaired for: Poor Biotic Integrity. All stormwater and dewatering discharges from the site are subject to an **effluent limit** of 8.5 su for pH or 25 NTU for turbidity.

TMDL Waterbodies (5.2)

The 303(d) list is used to determine what water quality improvements are most needed. The TMDL process is only used where it is determined it will be the most effective tool.

Discharges to TMDL receiving waterbodies will meet in-stream water quality criteria at the point of discharge.
--

The Construction Stormwater General Permit Proposed New Discharge to an Impaired Water Body form is included in Appendix F.

Reporting and Record Keeping (6.0)

Record Keeping (6.1)

Site Log Book (6.1.1)

A site log book will be maintained for all on-site construction activities and will include:

- A record of the implementation of the SWPPP and other permit requirements
- Site inspections
- Sample logs

Records Retention (6.1.2)

Records will be retained during the life of the project and for a minimum of three (3) years following the termination of permit coverage in accordance with Special Condition S5.C of the CSWGP.

Permit documentation to be retained on-site:

- CSWGP
- Permit Coverage Letter
- SWPPP
- Site Log Book

Permit documentation will be provided within 14 days of receipt of a written request from Ecology. A copy of the SWPPP or access to the SWPPP will be provided to the public when requested in writing in accordance with Special Condition S5.G.2.b of the CSWGP.

Updating the SWPPP (6.1.3)

The SWPPP will be modified if:

- Found ineffective in eliminating or significantly minimizing pollutants in stormwater discharges from the site.
- There is a change in design, construction, operation, or maintenance at the construction site that has, or could have, a significant effect on the discharge of pollutants to waters of the State.

The SWPPP will be modified within seven (7) days if inspection(s) or investigation(s) determine additional or modified BMPs are necessary for compliance. An updated timeline for BMP implementation will be prepared.

Reporting (6.2)

Discharge Monitoring Reports (6.2.1)

Cumulative soil disturbance is one (1) acre or larger; therefore, Discharge Monitoring Reports (DMRs) will be submitted to Ecology monthly. If there was no discharge during a given monitoring period the DMR will be submitted as required, reporting “No Discharge”. The DMR due date is fifteen (15) days following the end of each calendar month.

DMRs will be reported online through Ecology’s WQWebDMR System.

To sign up for WSWebDMR, visit:

<https://www.ecology.wa.gov/Regulations-Permits/Guidance-technical-assistance/Water-quality-permits-guidance/WQWebPortal-guidance>

Notification of Noncompliance (6.2.2)

If any of the terms and conditions of the permit is not met, and the resulting noncompliance may cause a threat to human health or the environment, the following actions will be taken:

1. Ecology will be notified within 24-hours of the failure to comply by calling the applicable Regional office ERTS phone number (Regional office numbers listed below).
2. Immediate action will be taken to prevent the discharge/pollution or otherwise stop or correct the noncompliance. If applicable, sampling and analysis of any noncompliance will be repeated immediately and the results submitted to Ecology within five (5) days of becoming aware of the violation.
3. A detailed written report describing the noncompliance will be submitted to Ecology within five (5) days, unless requested earlier by Ecology.

Anytime turbidity sampling indicates turbidity is 250 NTUs or greater, or water transparency is 6 cm or less, the Ecology Regional office will be notified by phone within 24 hours of analysis as required by Special Condition S5.A of the CSWGP.

- Central Region at (509) 575-2490 for Benton, Chelan, Douglas, Kittitas, Klickitat, Okanogan, or Yakima County
- Eastern Region at (509) 329-3400 for Adams, Asotin, Columbia, Ferry, Franklin, Garfield, Grant, Lincoln, Pend Oreille, Spokane, Stevens, Walla Walla, or Whitman County
- Northwest Region at (425) 649-7000 for Island, King, Kitsap, San Juan, Skagit, Snohomish, or Whatcom County
- Southwest Region at (360) 407-6300 for Clallam, Clark, Cowlitz, Grays Harbor, Jefferson, Lewis, Mason, Pacific, Pierce, Skamania, Thurston, or Wahkiakum

Include the following information:

1. Your name and / Phone number
2. Permit number

3. City / County of project
4. Sample results
5. Date / Time of call
6. Date / Time of sample
7. Project name

In accordance with Special Condition S4.D.5.b of the CSWGP, the Ecology Regional office will be notified if chemical treatment other than CO₂ sparging is planned for adjustment of high pH water.

Appendix/Glossary

Site Map



BMP Detail

Construction BMPs

High Visibility Plastic or Metal Fence (BMP C103)

Stabilized Construction Entrance (BMP C105)

Wheel Wash (BMP C106)

Temporary and Permanent Seeding (BMP C120)

Mulching (BMP C121)

Plastic Covering (BMP C123)

Concrete Handling (BMP C151)

Grass Lined Channels (BMP C200)

Check Dams (BMP C207)

Silt Fence (BMP C233)

Sediment Pond (BMP C241)

BMP C103: High Visibility Fence

Purpose

Fencing is intended to:

1. Restrict clearing to approved limits.
2. Prevent disturbance of sensitive areas, their buffers, and other areas required to be left undisturbed.
3. Limit construction traffic to designated construction entrances, exits, or internal roads.
4. Protect areas where marking with survey tape may not provide adequate protection.

Conditions of Use

To establish clearing limits plastic, fabric, or metal fence may be used:

- At the boundary of sensitive areas, their buffers, and other areas required to be left uncleared.
- As necessary to control vehicle access to and on the site.

Design and Installation Specifications

High visibility plastic fence shall be composed of a high-density polyethylene material and shall be at least four feet in height. Posts for the fencing shall be steel or wood and placed every 6 feet on center (maximum) or as needed to ensure rigidity. The fencing shall be fastened to the post every six inches with a polyethylene tie. On long continuous lengths of fencing, a tension wire or rope shall be used as a top stringer to prevent sagging between posts. The fence color shall be high visibility orange. The fence tensile strength shall be 360 lbs./ft. using the ASTM D4595 testing method.

If appropriate install fabric silt fence in accordance with [BMP C233: Silt Fence \(p.367\)](#) to act as high visibility fence. Silt fence shall be at least 3 feet high and must be highly visible to meet the requirements of this BMP.

Metal fences shall be designed and installed according to the manufacturer's specifications.

Metal fences shall be at least 3 feet high and must be highly visible.

Fences shall not be wired or stapled to trees.

Maintenance Standards

If the fence has been damaged or visibility reduced, it shall be repaired or replaced immediately and visibility restored.

BMP C105: Stabilized Construction Entrance / Exit

Purpose

Stabilized Construction entrances are established to reduce the amount of sediment transported onto paved roads by vehicles or equipment. This is done by constructing a stabilized pad of quarry spalls at entrances and exits for construction sites.

Conditions of Use

Construction entrances shall be stabilized wherever traffic will be entering or leaving a construction site if paved roads or other paved areas are within 1,000 feet of the site.

For residential construction provide stabilized construction entrances for each residence, rather than only at the main subdivision entrance. Stabilized surfaces shall be of sufficient length/width to provide vehicle access/parking, based on lot size/configuration.

On large commercial, highway, and road projects, the designer should include enough extra materials in the contract to allow for additional stabilized entrances not shown in the initial Construction SWPPP. It is difficult to determine exactly where access to these projects will take place; additional materials will enable the contractor to install them where needed.

Design and Installation Specifications

See [Figure II-4.1.1 Stabilized Construction Entrance \(p.273\)](#) for details. Note: the 100' minimum length of the entrance shall be reduced to the maximum practicable size when the size or configuration of the site does not allow the full length (100').

Construct stabilized construction entrances with a 12-inch thick pad of 4-inch to 8-inch quarry spalls, a 4-inch course of asphalt treated base (ATB), or use existing pavement. Do not use crushed concrete, cement, or calcium chloride for construction entrance stabilization because these products raise pH levels in stormwater and concrete discharge to surface waters of the State is prohibited.

A separation geotextile shall be placed under the spalls to prevent fine sediment from pumping up into the rock pad. The geotextile shall meet the following standards:

Grab Tensile Strength (ASTM D4751)	200 psi min.
Grab Tensile Elongation (ASTM D4632)	30% max.
Mullen Burst Strength (ASTM D3786-80a)	400 psi min.
AOS (ASTM D4751)	20-45 (U.S. standard sieve size)

- Consider early installation of the first lift of asphalt in areas that will be paved; this can be used as a stabilized entrance. Also consider the installation of excess concrete as a stabilized entrance. During large concrete pours, excess concrete is often available for this purpose.
- Fencing (see [BMP C103: High Visibility Fence \(p.269\)](#)) shall be installed as necessary to restrict traffic to the construction entrance.
- Whenever possible, the entrance shall be constructed on a firm, compacted sub-grade. This can substantially increase the effectiveness of the pad and reduce the need for maintenance.
- Construction entrances should avoid crossing existing sidewalks and back of walk drains if at all possible. If a construction entrance must cross a sidewalk or back of walk drain, the full length of the sidewalk and back of walk drain must be covered and protected from sediment leaving the site.

Maintenance Standards

Quarry spalls shall be added if the pad is no longer in accordance with the specifications.

- If the entrance is not preventing sediment from being tracked onto pavement, then alternative measures to keep the streets free of sediment shall be used. This may include replacement/cleaning of the existing quarry spalls, street sweeping, an increase in the dimensions of the entrance, or the installation of a wheel wash.
- Any sediment that is tracked onto pavement shall be removed by shoveling or street sweeping. The sediment collected by sweeping shall be removed or stabilized on site. The pavement shall not be cleaned by washing down the street, except when high efficiency sweeping is ineffective and there is a threat to public safety. If it is necessary to wash the streets, the construction of a small sump to contain the wash water shall be considered. The sediment would then be washed into the sump where it can be controlled.
- Perform street sweeping by hand or with a high efficiency sweeper. Do not use a non-high efficiency mechanical sweeper because this creates dust and throws soils into storm systems or conveyance ditches.

- Any quarry spalls that are loosened from the pad, which end up on the roadway shall be removed immediately.
- If vehicles are entering or exiting the site at points other than the construction entrance(s), fencing (see BMP C103) shall be installed to control traffic.
- Upon project completion and site stabilization, all construction accesses intended as permanent access for maintenance shall be permanently stabilized.

Figure II-4.1.1 Stabilized Construction Entrance

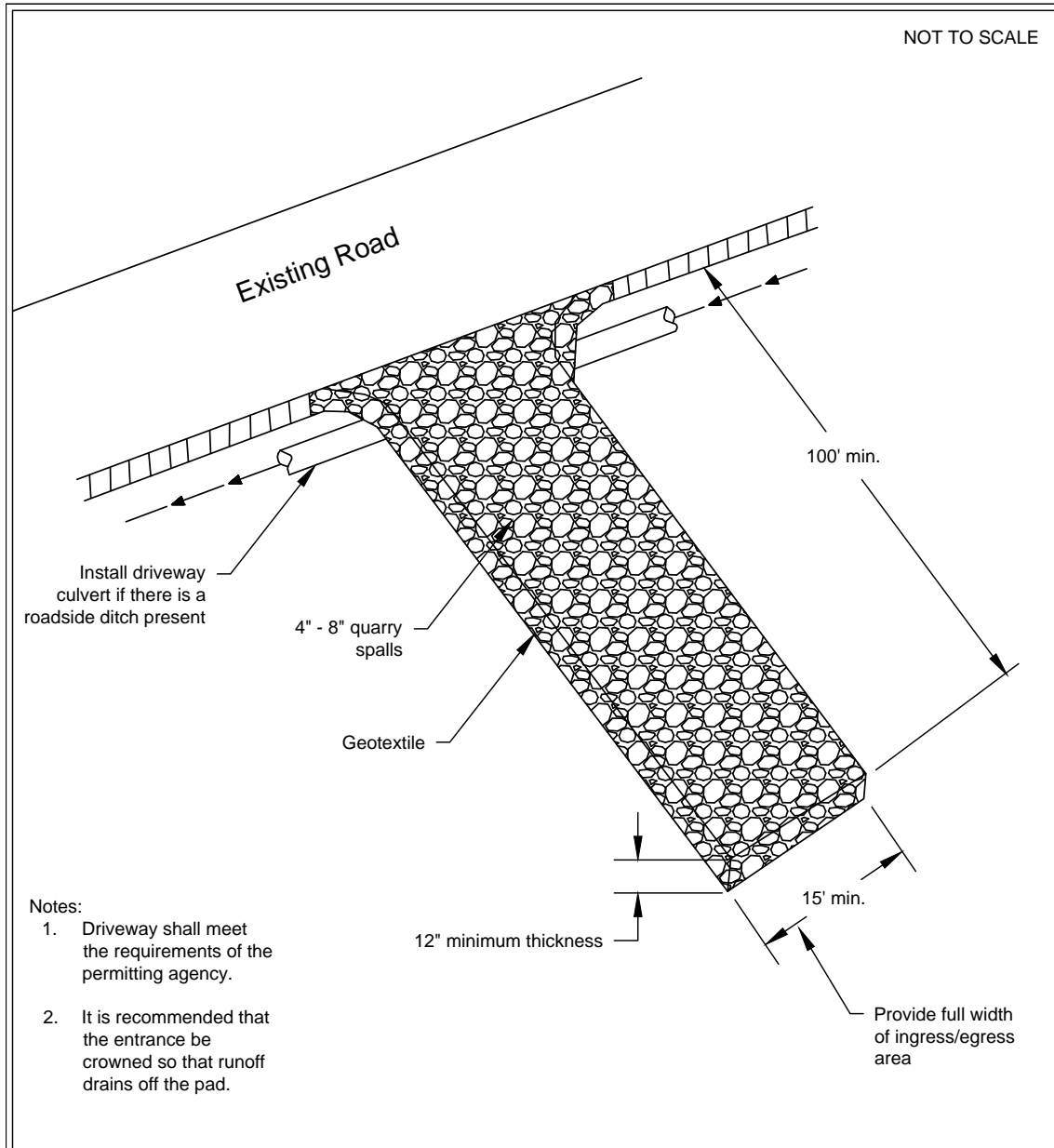

**Figure II-4.1.1
Stabilized Construction Entrance**

Revised June 2015

Please see <http://www.ecy.wa.gov/copyright.html> for copyright notice including permissions, limitation of liability, and disclaimer.

Approved as Equivalent

Ecology has approved products as able to meet the requirements of [BMP C105: Stabilized Construction Entrance / Exit](#). The products did not pass through the Technology Assessment Protocol – Ecology (TAPE) process. Local jurisdictions may choose not to accept this product approved as equivalent, or may require additional testing prior to consideration for local use. The products are available for review on Ecology’s website at <http://www.ecy.wa.gov/programs/wq/stormwater/newtech/equivalent.html>

BMP C106: Wheel Wash

Purpose Wheel washes reduce the amount of sediment transported onto paved roads by motor vehicles.

Conditions of Use When a stabilized construction entrance (see [BMP C105](#)) is not preventing sediment from being tracked onto pavement.

- Wheel washing is generally an effective BMP when installed with careful attention to topography. For example, a wheel wash can be detrimental if installed at the top of a slope abutting a right-of-way where the water from the dripping truck can run unimpeded into the street.

- Pressure washing combined with an adequately sized and surfaced pad with direct drainage to a large 10-foot x 10-foot sump can be very effective.
- Discharge wheel wash or tire bath wastewater to a separate on-site treatment system that prevents discharge to surface water, such as closed-loop recirculation or upland land application, or to the sanitary sewer with local sewer district approval.
- Wheel wash or tire bath wastewater should not include wastewater from concrete washout areas.

***Design and
Installation
Specifications***

Suggested details are shown in [Figure 4.1.2](#). The Local Permitting Authority may allow other designs. A minimum of 6 inches of asphalt treated base (ATB) over crushed base material or 8 inches over a good subgrade is recommended to pave the wheel wash.

Use a low clearance truck to test the wheel wash before paving. Either a belly dump or lowboy will work well to test clearance.

Keep the water level from 12 to 14 inches deep to avoid damage to truck hubs and filling the truck tongues with water.

Midpoint spray nozzles are only needed in extremely muddy conditions.

Wheel wash systems should be designed with a small grade change, 6- to 12-inches for a 10-foot-wide pond, to allow sediment to flow to the low side of pond to help prevent re-suspension of sediment. A drainpipe with a 2- to 3-foot riser should be installed on the low side of the pond to allow for easy cleaning and refilling. Polymers may be used to promote coagulation and flocculation in a closed-loop system. Polyacrylamide (PAM) added to the wheel wash water at a rate of 0.25 - 0.5 pounds per 1,000 gallons of water increases effectiveness and reduces cleanup time. If PAM is already being used for dust or erosion control and is being applied by a water truck, the same truck can be used to change the wash water.

***Maintenance
Standards***

The wheel wash should start out the day with fresh water.

The wash water should be changed a minimum of once per day. On large earthwork jobs where more than 10-20 trucks per hour are expected, the wash water will need to be changed more often.

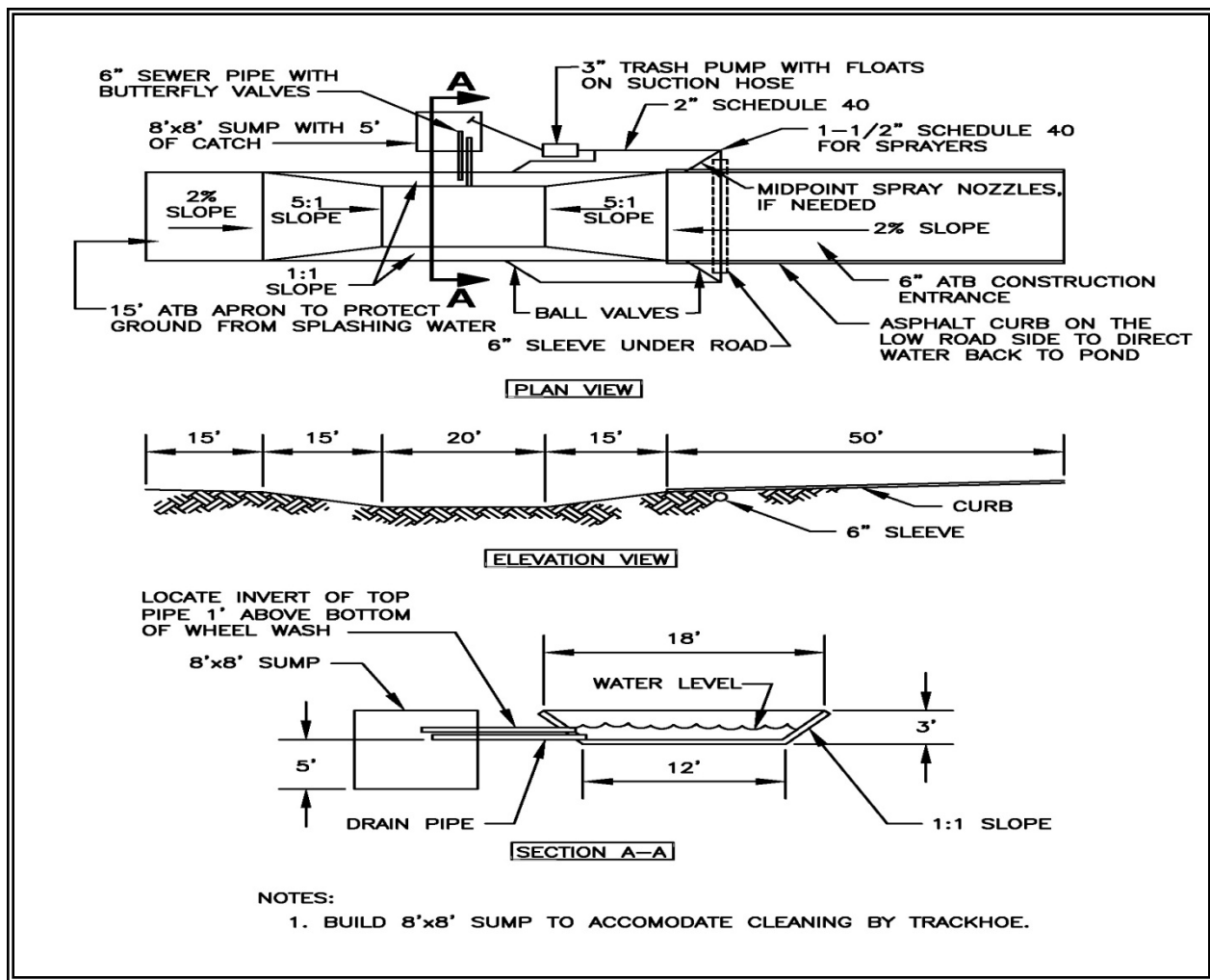

Figure 4.1.2 – Wheel Wash

Notes:

1. Asphalt construction entrance 6 in. asphalt treated base (ATB).
2. 3-inch trash pump with floats on the suction hose.
3. Midpoint spray nozzles, if needed.
4. 6-inch sewer pipe with butterfly valves. Bottom one is a drain. Locate top pipe's invert 1 foot above bottom of wheel wash.
5. 8 foot x 8 foot sump with 5 feet of catch. Build so the sump can be cleaned with a trackhoe.
6. Asphalt curb on the low road side to direct water back to pond.
7. 6-inch sleeve under road.
8. Ball valves.
9. 15 foot. ATB apron to protect ground from splashing water.

BMP C120: Temporary and Permanent Seeding

Purpose

Seeding reduces erosion by stabilizing exposed soils. A well-established vegetative cover is one of the most effective methods of reducing erosion.

Conditions of Use

Use seeding throughout the project on disturbed areas that have reached final grade or that will remain unworked for more than 30 days.

The optimum seeding windows for western Washington are April 1 through June 30 and September 1 through October 1.

Between July 1 and August 30 seeding requires irrigation until 75 percent grass cover is established.

Between October 1 and March 30 seeding requires a cover of mulch with straw or an erosion control blanket until 75 percent grass cover is established.

Review all disturbed areas in late August to early September and complete all seeding by the end of September. Otherwise, vegetation will not establish itself enough to provide more than average protection.

- Mulch is required at all times for seeding because it protects seeds from heat, moisture loss, and transport due to runoff. Mulch can be applied on top of the seed or simultaneously by hydroseeding. See [BMP C121: Mulching \(p.284\)](#) for specifications.
- Seed and mulch, all disturbed areas not otherwise vegetated at final site stabilization. Final stabilization means the completion of all soil disturbing activities at the site and the establishment of a permanent vegetative cover, or equivalent per-

manent stabilization measures (such as pavement, riprap, gabions, or geotextiles) which will prevent erosion.

Design and Installation Specifications

Seed retention/detention ponds as required.

Install channels intended for vegetation before starting major earthwork and hydroseed with a Bonded Fiber Matrix. For vegetated channels that will have high flows, install erosion control blankets over hydroseed. Before allowing water to flow in vegetated channels, establish 75 percent vegetation cover. If vegetated channels cannot be established by seed before water flow; install sod in the channel bottom—over hydromulch and erosion control blankets.

- Confirm the installation of all required surface water control measures to prevent seed from washing away.
- Hydroseed applications shall include a minimum of 1,500 pounds per acre of mulch with 3 percent tackifier. See [BMP C121: Mulching \(p.284\)](#) for specifications.
- Areas that will have seeding only and not landscaping may need compost or meal-based mulch included in the hydroseed in order to establish vegetation. Re-install native topsoil on the disturbed soil surface before application.
- When installing seed via hydroseeding operations, only about 1/3 of the seed actually ends up in contact with the soil surface. This reduces the ability to establish a good stand of grass quickly. To overcome this, consider increasing seed quantities by up to 50 percent.
- Enhance vegetation establishment by dividing the hydromulch operation into two phases:
 1. Phase 1- Install all seed and fertilizer with 25-30 percent mulch and tackifier onto soil in the first lift.
 2. Phase 2- Install the rest of the mulch and tackifier over the first lift.

Or, enhance vegetation by:

1. Installing the mulch, seed, fertilizer, and tackifier in one lift.
2. Spread or blow straw over the top of the hydromulch at a rate of 800-1000 pounds per acre.
3. Hold straw in place with a standard tackifier.

Both of these approaches will increase cost moderately but will greatly improve and enhance vegetative establishment. The increased cost may be offset by the reduced need for:

- Irrigation.
- Reapplication of mulch.
- Repair of failed slope surfaces.

This technique works with standard hydromulch (1,500 pounds per acre minimum) and BFM/MBFMs (3,000 pounds per acre minimum).

- Seed may be installed by hand if:
 - Temporary and covered by straw, mulch, or topsoil.
 - Permanent in small areas (usually less than 1 acre) and covered with mulch, topsoil, or erosion blankets.
 - The seed mixes listed in the tables below include recommended mixes for both temporary and permanent seeding.
 - Apply these mixes, with the exception of the wetland mix, at a rate of 120 pounds per acre. This rate can be reduced if soil amendments or slow-release fertilizers are used.
 - Consult the local suppliers or the local conservation district for their recommendations because the appropriate mix depends on a variety of factors, including location, exposure, soil type, slope, and expected foot traffic. Alternative seed mixes approved by the local authority may be used.
 - Other mixes may be appropriate, depending on the soil type and hydrology of the area.
- [Table II-4.1.2 Temporary Erosion Control Seed Mix \(p.280\)](#) lists the standard mix for areas requiring a temporary vegetative cover.

Table II-4.1.2 Temporary Erosion Control Seed Mix

	% Weight	% Purity	% Germination
Chewings or annual blue grass <i>Festuca rubra var. commutata</i> or <i>Poa anna</i>	40	98	90
Perennial rye <i>Lolium perenne</i>	50	98	90
Redtop or colonial bentgrass <i>Agrostis alba</i> or <i>Agrostis tenuis</i>	5	92	85
White dutch clover <i>Trifolium repens</i>	5	98	90

- [Table II-4.1.3 Landscaping Seed Mix \(p.281\)](#) lists a recommended mix for landscaping seed.

Table II-4.1.3 Landscaping Seed Mix

	% Weight	% Purity	% Germination
Perennial rye blend <i>Lolium perenne</i>	70	98	90
Chewings and red fescue blend <i>Festuca rubra</i> var. <i>commutata</i> or <i>Festuca rubra</i>	30	98	90

- [Table II-4.1.4 Low-Growing Turf Seed Mix \(p.281\)](#) lists a turf seed mix for dry situations where there is no need for watering. This mix requires very little maintenance.

Table II-4.1.4 Low-Growing Turf Seed Mix

	% Weight	% Purity	% Germination
Dwarf tall fescue (several varieties) <i>Festuca arundinacea</i> var.	45	98	90
Dwarf perennial rye (Barclay) <i>Lolium perenne</i> var. <i>barclay</i>	30	98	90
Red fescue <i>Festuca rubra</i>	20	98	90
Colonial bentgrass <i>Agrostis tenuis</i>	5	98	90

- [Table II-4.1.5 Bioswale Seed Mix* \(p.281\)](#) lists a mix for bioswales and other intermittently wet areas.

Table II-4.1.5 Bioswale Seed Mix*

	% Weight	% Purity	% Germination
Tall or meadow fescue <i>Festuca arundinacea</i> or <i>Festuca elatior</i>	75-80	98	90
Seaside/Creeping bentgrass <i>Agrostis palustris</i>	10-15	92	85
Redtop bentgrass <i>Agrostis alba</i> or <i>Agrostis gigantea</i>	5-10	90	80
* Modified Briargreen, Inc. Hydroseeding Guide Wetlands Seed Mix			

- [Table II-4.1.6 Wet Area Seed Mix* \(p.282\)](#) lists a low-growing, relatively non-invasive seed mix appropriate for very wet areas that are not regulated wetlands. Apply

this mixture at a rate of 60 pounds per acre. Consult Hydraulic Permit Authority (HPA) for seed mixes if applicable.

Table II-4.1.6 Wet Area Seed Mix*

	% Weight	% Purity	% Germination
Tall or meadow fescue <i>Festuca arundinacea</i> or <i>Festuca elatior</i>	60-70	98	90
Seaside/Creeping bentgrass <i>Agrostis palustris</i>	10-15	98	85
Meadow foxtail <i>Alepocurus pratensis</i>	10-15	90	80
Alsike clover <i>Trifolium hybridum</i>	1-6	98	90
Redtop bentgrass <i>Agrostis alba</i>	1-6	92	85
* Modified Briargreen, Inc. Hydroseeding Guide Wetlands Seed Mix			

- [Table II-4.1.7 Meadow Seed Mix \(p.282\)](#) lists a recommended meadow seed mix for infrequently maintained areas or non-maintained areas where colonization by native plants is desirable. Likely applications include rural road and utility right-of-way. Seeding should take place in September or very early October in order to obtain adequate establishment prior to the winter months. Consider the appropriateness of clover, a fairly invasive species, in the mix. Amending the soil can reduce the need for clover.

Table II-4.1.7 Meadow Seed Mix

	% Weight	% Purity	% Germination
Redtop or Oregon bentgrass <i>Agrostis alba</i> or <i>Agrostis oregonensis</i>	20	92	85
Red fescue <i>Festuca rubra</i>	70	98	90
White dutch clover <i>Trifolium repens</i>	10	98	90

• **Roughening and Rototilling:**

- The seedbed should be firm and rough. Roughen all soil no matter what the slope. Track walk slopes before seeding if engineering purposes require

compaction. Backblading or smoothing of slopes greater than 4H:1V is not allowed if they are to be seeded.

- Restoration-based landscape practices require deeper incorporation than that provided by a simple single-pass rototilling treatment. Wherever practical, initially rip the subgrade to improve long-term permeability, infiltration, and water inflow qualities. At a minimum, permanent areas shall use soil amendments to achieve organic matter and permeability performance defined in engineered soil/landscape systems. For systems that are deeper than 8 inches complete the rototilling process in multiple lifts, or prepare the engineered soil system per specifications and place to achieve the specified depth.

- **Fertilizers:**

- Conducting soil tests to determine the exact type and quantity of fertilizer is recommended. This will prevent the over-application of fertilizer.
- Organic matter is the most appropriate form of fertilizer because it provides nutrients (including nitrogen, phosphorus, and potassium) in the least water-soluble form.
- In general, use 10-4-6 N-P-K (nitrogen-phosphorus-potassium) fertilizer at a rate of 90 pounds per acre. Always use slow-release fertilizers because they are more efficient and have fewer environmental impacts. Do not add fertilizer to the hydromulch machine, or agitate, more than 20 minutes before use. Too much agitation destroys the slow-release coating.
- There are numerous products available that take the place of chemical fertilizers. These include several with seaweed extracts that are beneficial to soil microbes and organisms. If 100 percent cottonseed meal is used as the mulch in hydroseed, chemical fertilizer may not be necessary. Cottonseed meal provides a good source of long-term, slow-release, available nitrogen.

- **Bonded Fiber Matrix and Mechanically Bonded Fiber Matrix:**

- On steep slopes use Bonded Fiber Matrix (BFM) or Mechanically Bonded Fiber Matrix (MBFM) products. Apply BFM/MBFM products at a minimum rate of 3,000 pounds per acre of mulch with approximately 10 percent tackifier. Achieve a minimum of 95 percent soil coverage during application. Numerous products are available commercially. Installed products per manufacturer's instructions. Most products require 24-36 hours to cure before rainfall and cannot be installed on wet or saturated soils. Generally, products come in 40-50 pound bags and include all necessary ingredients except for seed and fertilizer.

- BFM and MBFMs provide good alternatives to blankets in most areas requiring vegetation establishment. Advantages over blankets include:
 - BFM and MBFMs do not require surface preparation.
 - Helicopters can assist in installing BFM and MBFMs in remote areas.
 - On slopes steeper than 2.5H:1V, blanket installers may require ropes and harnesses for safety.
 - Installing BFM and MBFMs can save at least \$1,000 per acre compared to blankets.

Maintenance Standards

Reseed any seeded areas that fail to establish at least 80 percent cover (100 percent cover for areas that receive sheet or concentrated flows). If reseeding is ineffective, use an alternate method such as sodding, mulching, or nets/blankets. If winter weather prevents adequate grass growth, this time limit may be relaxed at the discretion of the local authority when sensitive areas would otherwise be protected.

- Reseed and protect by mulch any areas that experience erosion after achieving adequate cover. Reseed and protect by mulch any eroded area.
- Supply seeded areas with adequate moisture, but do not water to the extent that it causes runoff.

Approved as Equivalent

Ecology has approved products as able to meet the requirements of [BMP C120: Temporary and Permanent Seeding](#). The products did not pass through the Technology Assessment Protocol – Ecology (TAPE) process. Local jurisdictions may choose not to accept this product approved as equivalent, or may require additional testing prior to consideration for local use. The products are available for review on Ecology’s website at <http://www.ecy.wa.gov/programs/wq/stormwater/newtech/equivalent.html>.

BMP C121: Mulching

Purpose

Mulching soils provides immediate temporary protection from erosion. Mulch also enhances plant establishment by conserving moisture, holding fertilizer, seed, and top-soil in place, and moderating soil temperatures. There is an enormous variety of mulches that can be used. This section discusses only the most common types of mulch.

Conditions of Use

As a temporary cover measure, mulch should be used:

- For less than 30 days on disturbed areas that require cover.
- At all times for seeded areas, especially during the wet season and during the hot summer months.
- During the wet season on slopes steeper than 3H:1V with more than 10 feet of vertical relief.

Mulch may be applied at any time of the year and must be refreshed periodically.

- For seeded areas mulch may be made up of 100 percent: cottonseed meal; fibers made of wood, recycled cellulose, hemp, kenaf; compost; or blends of these. Tackifier shall be plant-based, such as guar or alpha plantago, or chemical-based such as polyacrylamide or polymers. Any mulch or tackifier product used shall be installed per manufacturer's instructions. Generally, mulches come in 40-50 pound bags. Seed and fertilizer are added at time of application.

Design and Installation Specifications

For mulch materials, application rates, and specifications, see [Table II-4.1.8 Mulch Standards and Guidelines \(p.286\)](#). Always use a 2-inch minimum mulch thickness; increase the thickness until the ground is 95% covered (i.e. not visible under the mulch layer). Note: Thickness may be increased for disturbed areas in or near sensitive areas or other areas highly susceptible to erosion.

Where the option of "Compost" is selected, it should be a coarse compost that meets the following size gradations when tested in accordance with the U.S. Composting Council "Test Methods for the Examination of Compost and Composting" (TMECC) Test Method 02.02-B.

Coarse Compost

Minimum Percent passing 3" sieve openings 100%

Minimum Percent passing 1" sieve openings 90%

Minimum Percent passing ¾" sieve openings 70%

Minimum Percent passing ¼" sieve openings 40%

Mulch used within the ordinary high-water mark of surface waters should be selected to minimize potential flotation of organic matter. Composted organic materials have higher specific gravities (densities) than straw, wood, or chipped material. Consult Hydraulic Permit Authority (HPA) for mulch mixes if applicable.

Maintenance Standards

- The thickness of the cover must be maintained.
- Any areas that experience erosion shall be remulched and/or protected with a net

or blanket. If the erosion problem is drainage related, then the problem shall be fixed and the eroded area remulched.

Table II-4.1.8 Mulch Standards and Guidelines

Mulch Material	Quality Standards	Application Rates	Remarks
Straw	Air-dried; free from undesirable seed and coarse material.	2"-3" thick; 5 bales per 1,000 sf or 2-3 tons per acre	Cost-effective protection when applied with adequate thickness. Hand-application generally requires greater thickness than blown straw. The thickness of straw may be reduced by half when used in conjunction with seeding. In windy areas straw must be held in place by crimping, using a tackifier, or covering with netting. Blown straw always has to be held in place with a tackifier as even light winds will blow it away. Straw, however, has several deficiencies that should be considered when selecting mulch materials. It often introduces and/or encourages the propagation of weed species and it has no significant long-term benefits. It should also not be used within the ordinary high-water elevation of surface waters (due to flotation).
Hydromulch	No growth inhibiting factors.	Approx. 25-30 lbs per 1,000 sf or 1,500 - 2,000 lbs per acre	Shall be applied with hydromulcher. Shall not be used without seed and tackifier unless the application rate is at least doubled. Fibers longer than about 3/4 - 1 inch clog hydromulch equipment. Fibers should be kept to less than 3/4 inch.
Compost	No visible water or dust during handling. Must be produced per WAC 173-350, Solid Waste Handling Standards, but may have up to 35%	2" thick min.; approx. 100 tons per acre (approx. 800 lbs per yard)	More effective control can be obtained by increasing thickness to 3". Excellent mulch for protecting final grades until landscaping because it can be directly seeded or tilled into soil as an amendment. Compost used for mulch has a coarser size gradation than compost used for BMP C125: Topsoiling / Composting (p.297) or BMP T5.13: Post-Construction Soil Quality and Depth (p.911) . It is more stable and practical to use in wet areas and during rainy weather conditions. Do not use near wetlands or near phosphorous impaired water bodies.

Table II-4.1.8 Mulch Standards and Guidelines (continued)

Mulch Material	Quality Standards	Application Rates	Remarks
	biosolids.		
Chipped Site Vegetation	Average size shall be several inches. Gradations from fines to 6 inches in length for texture, variation, and interlocking properties.	2" thick min.;	This is a cost-effective way to dispose of debris from clearing and grubbing, and it eliminates the problems associated with burning. Generally, it should not be used on slopes above approx. 10% because of its tendency to be transported by runoff. It is not recommended within 200 feet of surface waters. If seeding is expected shortly after mulch, the decomposition of the chipped vegetation may tie up nutrients important to grass establishment.
Wood-based Mulch or Wood Straw	No visible water or dust during handling. Must be purchased from a supplier with a Solid Waste Handling Permit or one exempt from solid waste regulations.	2" thick min.; approx. 100 tons per acre (approx. 800 lbs. per cubic yard)	This material is often called "hog or hogged fuel". The use of mulch ultimately improves the organic matter in the soil. Special caution is advised regarding the source and composition of wood-based mulches. Its preparation typically does not provide any weed seed control, so evidence of residual vegetation in its composition or known inclusion of weed plants or seeds should be monitored and prevented (or minimized).
Wood Strand Mulch	A blend of loose, long, thin wood pieces derived from native conifer or deciduous trees with	2" thick min.	Cost-effective protection when applied with adequate thickness. A minimum of 95-percent of the wood strand shall have lengths between 2 and 10-inches, with a width and thickness between 1/16 and 3/8-inches. The mulch shall not contain resin, tannin, or other compounds in quantities that would be detrimental to plant life. Sawdust or wood shavings shall not be used as mulch. (WSDOT specification (9-14.4(4)))

Table II-4.1.8 Mulch Standards and Guidelines (continued)

Mulch Material	Quality Standards	Application Rates	Remarks
	high length-to-width ratio.		

BMP C123: Plastic Covering

Purpose

Plastic covering provides immediate, short-term erosion protection to slopes and disturbed areas.

Conditions of Use

Plastic covering may be used on disturbed areas that require cover measures for less than 30 days, except as stated below.

- Plastic is particularly useful for protecting cut and fill slopes and stockpiles. Note: The relatively rapid breakdown of most polyethylene sheeting makes it unsuitable for long-term (greater than six months) applications.
- Due to rapid runoff caused by plastic covering, do not use this method upslope of areas that might be adversely impacted by concentrated runoff. Such areas include steep and/or unstable slopes.
- Plastic sheeting may result in increased runoff volumes and velocities, requiring additional on-site measures to counteract the increases. Creating a trough with wattles or other material can convey clean water away from these areas.
- To prevent undercutting, trench and backfill rolled plastic covering products.
- While plastic is inexpensive to purchase, the added cost of installation, maintenance, removal, and disposal make this an expensive material, up to \$1.50-2.00 per square yard.
- Whenever plastic is used to protect slopes install water collection measures at the base of the slope. These measures include plastic-covered berms, channels, and pipes used to convey clean rainwater away from bare soil and disturbed areas. Do not mix clean runoff from a plastic covered slope with dirty runoff from a project.
- Other uses for plastic include:
 1. Temporary ditch liner.
 2. Pond liner in temporary sediment pond.
 3. Liner for bermed temporary fuel storage area if plastic is not reactive to the type of fuel being stored.
 4. Emergency slope protection during heavy rains.
 5. Temporary drainpipe (“elephant trunk”) used to direct water.

Design and Installation Specifications

- Plastic slope cover must be installed as follows:
 1. Run plastic up and down slope, not across slope.
 2. Plastic may be installed perpendicular to a slope if the slope length is less than 10 feet.
 3. Minimum of 8-inch overlap at seams.
 4. On long or wide slopes, or slopes subject to wind, tape all seams.
 5. Place plastic into a small (12-inch wide by 6-inch deep) slot trench at the top of the slope and backfill with soil to keep water from flowing underneath.
 6. Place sand filled burlap or geotextile bags every 3 to 6 feet along seams and tie them together with twine to hold them in place.
 7. Inspect plastic for rips, tears, and open seams regularly and repair immediately. This prevents high velocity runoff from contacting bare soil which causes extreme erosion.
 8. Sandbags may be lowered into place tied to ropes. However, all sandbags must be staked in place.
- Plastic sheeting shall have a minimum thickness of 0.06 millimeters.
- If erosion at the toe of a slope is likely, a gravel berm, riprap, or other suitable protection shall be installed at the toe of the slope in order to reduce the velocity of runoff.

Maintenance Standards

- Torn sheets must be replaced and open seams repaired.
- Completely remove and replace the plastic if it begins to deteriorate due to ultra-violet radiation.
- Completely remove plastic when no longer needed.
- Dispose of old tires used to weight down plastic sheeting appropriately.

Approved as Equivalent

Ecology has approved products as able to meet the requirements of [BMP C123: Plastic Covering](#). The products did not pass through the Technology Assessment Protocol – Ecology (TAPE) process. Local jurisdictions may choose not to accept this product approved as equivalent, or may require additional testing prior to consideration for local use. The products are available for review on Ecology’s website at <http://www.ecy.wa.gov/programs/wq/stormwater/newtech/equivalent.html>

BMP C151: Concrete Handling

Purpose

Concrete work can generate process water and slurry that contain fine particles and high pH, both of which can violate water quality standards in the receiving water. Concrete spillage or concrete discharge to surface waters of the State is prohibited. Use this BMP to minimize and eliminate concrete, concrete process water, and concrete slurry from entering waters of the state.

Conditions of Use

Any time concrete is used, utilize these management practices. Concrete construction projects include, but are not limited to, the following:

- Curbs
- Sidewalks
- Roads
- Bridges
- Foundations
- Floors
- Runways

Design and Installation Specifications

- Assure that washout of concrete trucks, chutes, pumps, and internals is performed at an approved off-site location or in designated concrete washout areas. Do not wash out concrete trucks onto the ground, or into storm drains, open ditches, streets, or streams. Refer to [BMP C154: Concrete Washout Area \(p.317\)](#) for information on concrete washout areas.
- Return unused concrete remaining in the truck and pump to the originating batch plant for recycling. Do not dump excess concrete on site, except in designated concrete washout areas.
- Wash off hand tools including, but not limited to, screeds, shovels, rakes, floats, and trowels into formed areas only.
- Wash equipment difficult to move, such as concrete pavers in areas that do not directly drain to natural or constructed stormwater conveyances.
- Do not allow washdown from areas, such as concrete aggregate driveways, to drain directly to natural or constructed stormwater conveyances.
- Contain washwater and leftover product in a lined container when no formed areas

are available. Dispose of contained concrete in a manner that does not violate ground water or surface water quality standards.

- Always use forms or solid barriers for concrete pours, such as pilings, within 15-feet of surface waters.
- Refer to [BMP C252: High pH Neutralization Using CO2 \(p.409\)](#) and [BMP C253: pH Control for High pH Water \(p.412\)](#) for pH adjustment requirements.
- Refer to the Construction Stormwater General Permit for pH monitoring requirements if the project involves one of the following activities:
 - Significant concrete work (greater than 1,000 cubic yards poured concrete or recycled concrete used over the life of a project).
 - The use of engineered soils amended with (but not limited to) Portland cement-treated base, cement kiln dust or fly ash.
 - Discharging stormwater to segments of water bodies on the 303(d) list (Category 5) for high pH.

Maintenance Standards

Check containers for holes in the liner daily during concrete pours and repair the same day.

BMP C200: Interceptor Dike and Swale

Purpose

Provide a dike of compacted soil or a swale at the top or base of a disturbed slope or along the perimeter of a disturbed construction area to convey stormwater. Use the dike and/or swale to intercept the runoff from unprotected areas and direct it to areas where erosion can be controlled. This can prevent storm runoff from entering the work area or sediment-laden runoff from leaving the construction site.

Conditions of Use

Use an interceptor dike or swale where runoff from an exposed site or disturbed slope must be conveyed to an erosion control BMP which can safely convey the stormwater.

- Locate upslope of a construction site to prevent runoff from entering the disturbed area.
- When placed horizontally across a disturbed slope, it reduces the amount and velocity of runoff flowing down the slope.
- Locate downslope to collect runoff from a disturbed area and direct it to a sediment BMP (e.g. [BMP C240: Sediment Trap](#) or [BMP C241: Sediment Pond \(Temporary\)](#)).

Design and Installation Specifications

- Dike and/or swale and channel must be stabilized with temporary or permanent vegetation or other channel protection during construction.
 - Steep grades require channel protection and check dams.
 - Review construction for areas where overtopping may occur.
 - Can be used at the top of new fill before vegetation is established.
 - May be used as a permanent diversion channel to carry the runoff.
 - Contributing area for an individual dike or swale should be one acre or less.
 - Design the dike and/or swale to contain flows calculated by one of the following methods:
 - Single Event Hydrograph Method: The peak volumetric flow rate calculated using a 10-minute time step from a Type 1A, 10-year, 24-hour frequency storm for the worst-case land cover condition.
- OR
- Continuous Simulation Method: The 10-year peak flow rate, as determined by an approved continuous runoff model with a 15-minute time step for the worst-case land cover condition.

Worst-case land cover conditions (i.e., producing the most runoff) should be used for analysis (in most cases, this would be the land cover conditions just prior to final landscaping).

Interceptor Dikes

Interceptor dikes shall meet the following criteria:

- Top Width: 2 feet minimum.
- Height: 1.5 feet minimum on berm.
- Side Slope: 2H:1V or flatter.
- Grade: Depends on topography, however, dike system minimum is 0.5%, and maximum is 1%.
- Compaction: Minimum of 90 percent ASTM D698 standard proctor.
- Stabilization: Depends on velocity and reach. Inspect regularly to ensure stability.
- Ground Slopes <5%: Seed and mulch applied within 5 days of dike construction (see [BMP C121: Mulching](#)).
- Ground Slopes 5 - 40%: Dependent on runoff velocities and dike materials. Stabilization should be done immediately using either sod or riprap, or other measures to avoid erosion.
- The upslope side of the dike shall provide positive drainage to the dike outlet. No erosion shall

occur at the outlet. Provide energy dissipation measures as necessary. Sediment-laden runoff must be released through a sediment trapping facility.

- Minimize construction traffic over temporary dikes. Use temporary cross culverts for channel crossing.
- See [Table II-3.8: Horizontal Spacing of Interceptor Dikes Along Ground Slope](#) for recommended horizontal spacing between dikes.

Table II-3.8: Horizontal Spacing of Interceptor Dikes Along Ground Slope

Average Slope	Slope Percent	Flowpath Length
20H:1V or less	3-5%	300 feet
(10 to 20)H:1V	5-10%	200 feet
(4 to 10)H:1V	10-25%	100 feet
(2 to 4)H:1V	25-50%	50 feet

Interceptor Swales

Interceptor swales shall meet the following criteria:

- Bottom Width: 2 feet minimum; the cross-section bottom shall be level.
- Depth: 1-foot minimum.
- Side Slope: 2H:1V or flatter.
- Grade: Maximum 5 percent, with positive drainage to a suitable outlet (such as [BMP C241: Sediment Pond \(Temporary\)](#)).
- Stabilization: Seed as per [BMP C120: Temporary and Permanent Seeding](#), or [BMP C202: Riprap Channel Lining](#), 12 inches thick riprap pressed into the bank and extending at least 8 inches vertical from the bottom.

Maintenance Standards

- Inspect diversion dikes and interceptor swales once a week and after every rainfall. Immediately remove sediment from the flow area.
- Damage caused by construction traffic or other activity must be repaired before the end of each working day.
- Check outlets and make timely repairs as needed to avoid gully formation. When the area below the temporary diversion dike is permanently stabilized, remove the dike and fill and stabilize the channel to blend with the natural surface.

BMP C207: Check Dams

Purpose

Construction of small dams across a swale or ditch reduces the velocity of concentrated flow and dissipates energy at the check dam.

Conditions of Use

Where temporary channels or permanent channels are not yet vegetated, channel lining is infeasible, and/or velocity checks are required.

- Check dams may not be placed in streams unless approved by the State Department of Fish and Wildlife. Check dams may not be placed in wetlands without approval from a permitting agency.
- Do not place check dams below the expected backwater from any salmonid bearing water between October 1 and May 31 to ensure that there is no loss of high flow refuge habitat for overwintering juvenile salmonids and emergent salmonid fry.
- Construct rock check dams from appropriately sized rock. The rock used must be large enough to stay in place given the expected design flow through the channel. The rock must be placed by hand or by mechanical means (no dumping of rock to form dam) to achieve complete coverage of the ditch or swale and to ensure that the center of the dam is lower than the edges.
- Check dams may also be constructed of either rock or pea-gravel filled bags. Numerous new products are also available for this purpose. They tend to be reusable, quick and easy to install, effective, and cost efficient.
- Place check dams perpendicular to the flow of water.
- The dam should form a triangle when viewed from the side. This prevents undercutting as water flows over the face of the dam rather than falling directly onto the ditch bottom.
- Before installing check dams impound and bypass upstream water flow away from the work area. Options for bypassing include pumps, siphons, or temporary channels.
- Check dams in association with sumps work more effectively at slowing flow and retaining sediment than just a check dam alone. A deep sump should be provided immediately upstream of the check dam.
- In some cases, if carefully located and designed, check dams can remain as permanent installations with very minor regrading. They may be left as either spillways, in which case accumulated sediment would be graded and seeded, or as

check dams to prevent further sediment from leaving the site.

- The maximum spacing between the dams shall be such that the toe of the upstream dam is at the same elevation as the top of the downstream dam.
- Keep the maximum height at 2 feet at the center of the dam.
- Keep the center of the check dam at least 12 inches lower than the outer edges at natural ground elevation.
- Keep the side slopes of the check dam at 2H:1V or flatter.
- Key the stone into the ditch banks and extend it beyond the abutments a minimum of 18 inches to avoid washouts from overflow around the dam.
- Use filter fabric foundation under a rock or sand bag check dam. If a blanket ditch liner is used, filter fabric is not necessary. A piece of organic or synthetic blanket cut to fit will also work for this purpose.
- In the case of grass-lined ditches and swales, all check dams and accumulated sediment shall be removed when the grass has matured sufficiently to protect the ditch or swale - unless the slope of the swale is greater than 4 percent. The area beneath the check dams shall be seeded and mulched immediately after dam removal.
- Ensure that channel appurtenances, such as culvert entrances below check dams, are not subject to damage or blockage from displaced stones. [Figure II-4.2.7 Rock Check Dam \(p.354\)](#) depicts a typical rock check dam.

Maintenance Standards

Check dams shall be monitored for performance and sediment accumulation during and after each runoff producing rainfall. Sediment shall be removed when it reaches one half the sump depth.

- Anticipate submergence and deposition above the check dam and erosion from high flows around the edges of the dam.
- If significant erosion occurs between dams, install a protective riprap liner in that portion of the channel.

Approved as Equivalent

Ecology has approved products as able to meet the requirements of [BMP C207: Check Dams](#). The products did not pass through the Technology Assessment Protocol – Ecology (TAPE) process. Local jurisdictions may choose not to accept this product approved as equivalent, or may require additional testing prior to consideration for local use. The products are available for review on Ecology’s website at <http://www.ecy.wa.gov/programs/wq/stormwater/newtech/equivalent.html>

Figure II-4.2.7 Rock Check Dam

View Looking Upstream

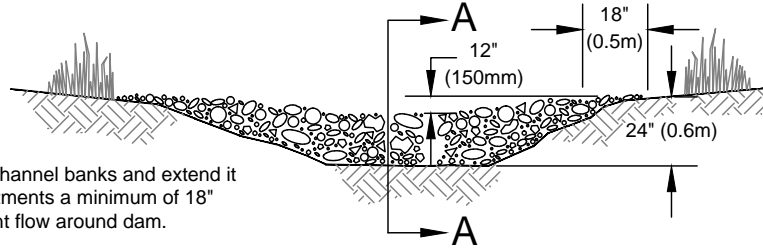

Note:
Key stone into channel banks and extend it beyond the abutments a minimum of 18" (0.5m) to prevent flow around dam.

Section A-A

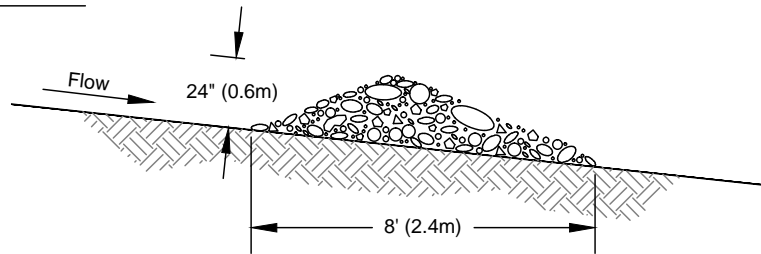

Spacing Between Check Dams

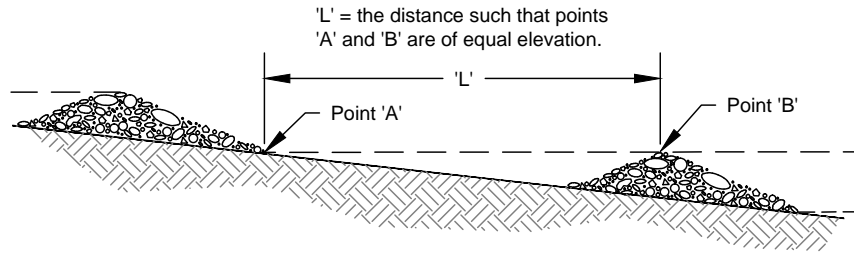

NOT TO SCALE



**Figure II-4.2.7
Rock Check Dam**

Revised July 2015

Please see <http://www.ecy.wa.gov/copyright.html> for copyright notice including permissions, limitation of liability, and disclaimer.

BMP C233: Silt Fence

Purpose

Use of a silt fence reduces the transport of coarse sediment from a construction site by providing a temporary physical barrier to sediment and reducing the runoff velocities of overland flow. See [Figure II-4.2.12 Silt Fence \(p.369\)](#) for details on silt fence construction.

Conditions of Use

Silt fence may be used downslope of all disturbed areas.

- Silt fence shall prevent soil carried by runoff water from going beneath, through, or over the top of the silt fence, but shall allow the water to pass through the fence.
- Silt fence is not intended to treat concentrated flows, nor is it intended to treat substantial amounts of overland flow. Convey any concentrated flows through the drainage system to a sediment pond.
- Do not construct silt fences in streams or use in V-shaped ditches. Silt fences do not provide an adequate method of silt control for anything deeper than sheet or overland flow.

Figure II-4.2.12 Silt Fence

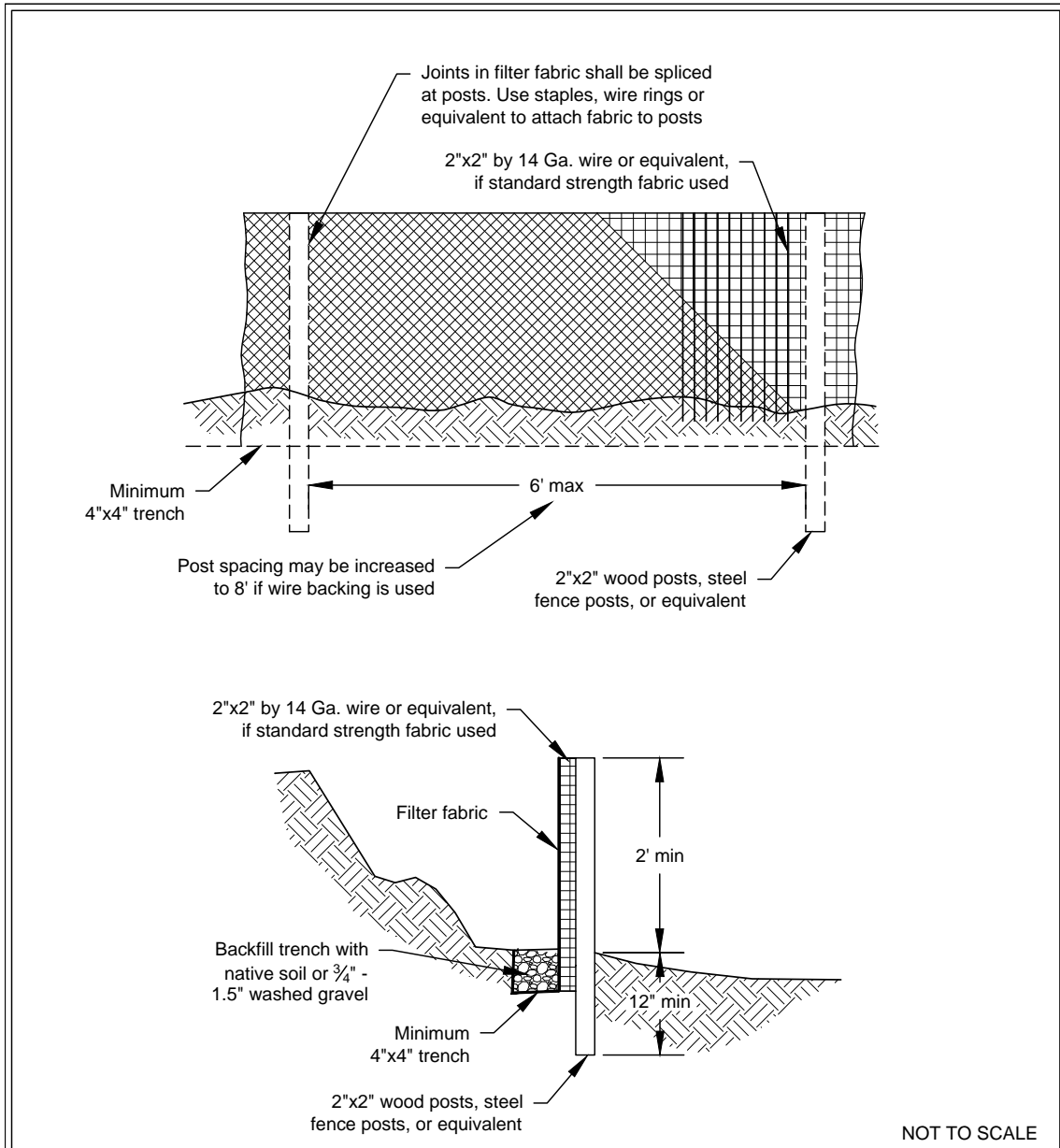

**Figure II-4.2.12
Silt Fence**

Revised October 2014

Please see <http://www.ecy.wa.gov/copyright.html> for copyright notice including permissions, limitation of liability, and disclaimer.

Design and Installation Specifications

- Use in combination with sediment basins or other BMPs.
- Maximum slope steepness (normal (perpendicular) to fence line) 1H:1V.
- Maximum sheet or overland flow path length to the fence of 100 feet.
- Do not allow flows greater than 0.5 cfs.
- The geotextile used shall meet the following standards. All geotextile properties listed below are minimum average roll values (i.e., the test result for any sampled roll in a lot shall meet or exceed the values shown in [Table II-4.2.3 Geotextile Standards \(p.370\)](#)):

Table II-4.2.3 Geotextile Standards

Polymeric Mesh AOS (ASTM D4751)	0.60 mm maximum for slit film woven (#30 sieve). 0.30 mm maximum for all other geotextile types (#50 sieve). 0.15 mm minimum for all fabric types (#100 sieve).
Water Permittivity (ASTM D4491)	0.02 sec ⁻¹ minimum
Grab Tensile Strength (ASTM D4632)	180 lbs. Minimum for extra strength fabric. 100 lbs minimum for standard strength fabric.
Grab Tensile Strength (ASTM D4632)	30% maximum
Ultraviolet Resistance (ASTM D4355)	70% minimum

- Support standard strength fabrics with wire mesh, chicken wire, 2-inch x 2-inch wire, safety fence, or jute mesh to increase the strength of the fabric. Silt fence materials are available that have synthetic mesh backing attached.
- Filter fabric material shall contain ultraviolet ray inhibitors and stabilizers to provide a minimum of six months of expected usable construction life at a temperature range of 0°F. to 120°F.
- One-hundred percent biodegradable silt fence is available that is strong, long lasting, and can be left in place after the project is completed, if permitted by local regulations.
- Refer to [Figure II-4.2.12 Silt Fence \(p.369\)](#) for standard silt fence details. Include the following standard Notes for silt fence on construction plans and specifications:

1. The contractor shall install and maintain temporary silt fences at the locations shown in the Plans.
2. Construct silt fences in areas of clearing, grading, or drainage prior to starting those activities.
3. The silt fence shall have a 2-foot min. and a 2½-foot max. height above the original ground surface.
4. The filter fabric shall be sewn together at the point of manufacture to form filter fabric lengths as required. Locate all sewn seams at support posts. Alternatively, two sections of silt fence can be overlapped, provided the Contractor can demonstrate, to the satisfaction of the Engineer, that the overlap is long enough and that the adjacent fence sections are close enough together to prevent silt laden water from escaping through the fence at the overlap.
5. Attach the filter fabric on the up-slope side of the posts and secure with staples, wire, or in accordance with the manufacturer's recommendations. Attach the filter fabric to the posts in a manner that reduces the potential for tearing.
6. Support the filter fabric with wire or plastic mesh, dependent on the properties of the geotextile selected for use. If wire or plastic mesh is used, fasten the mesh securely to the up-slope side of the posts with the filter fabric up-slope of the mesh.
7. Mesh support, if used, shall consist of steel wire with a maximum mesh spacing of 2-inches, or a prefabricated polymeric mesh. The strength of the wire or polymeric mesh shall be equivalent to or greater than 180 lbs. grab tensile strength. The polymeric mesh must be as resistant to the same level of ultra-violet radiation as the filter fabric it supports.
8. Bury the bottom of the filter fabric 4-inches min. below the ground surface. Backfill and tamp soil in place over the buried portion of the filter fabric, so that no flow can pass beneath the fence and scouring cannot occur. When wire or polymeric back-up support mesh is used, the wire or polymeric mesh shall extend into the ground 3-inches min.
9. Drive or place the fence posts into the ground 18-inches min. A 12-inch min. depth is allowed if topsoil or other soft subgrade soil is not present and 18-inches cannot be reached. Increase fence post min. depths by 6 inches if the fence is located on slopes of 3H:1V or steeper and the slope is perpendicular to the fence. If required post depths cannot be obtained, the posts shall be adequately secured by bracing or guying to prevent overturning of the fence due to sediment loading.
10. Use wood, steel or equivalent posts. The spacing of the support posts shall

be a maximum of 6-feet. Posts shall consist of either:

- Wood with dimensions of 2-inches by 2-inches wide min. and a 3-foot min. length. Wood posts shall be free of defects such as knots, splits, or gouges.
 - No. 6 steel rebar or larger.
 - ASTM A 120 steel pipe with a minimum diameter of 1-inch.
 - U, T, L, or C shape steel posts with a minimum weight of 1.35 lbs./ft.
 - Other steel posts having equivalent strength and bending resistance to the post sizes listed above.
11. Locate silt fences on contour as much as possible, except at the ends of the fence, where the fence shall be turned uphill such that the silt fence captures the runoff water and prevents water from flowing around the end of the fence.
 12. If the fence must cross contours, with the exception of the ends of the fence, place gravel check dams perpendicular to the back of the fence to minimize concentrated flow and erosion. The slope of the fence line where contours must be crossed shall not be steeper than 3H:1V.
 - Gravel check dams shall be approximately 1-foot deep at the back of the fence. Gravel check dams shall be continued perpendicular to the fence at the same elevation until the top of the check dam intercepts the ground surface behind the fence.
 - Gravel check dams shall consist of crushed surfacing base course, gravel backfill for walls, or shoulder ballast. Gravel check dams shall be located every 10 feet along the fence where the fence must cross contours.
- Refer to [Figure II-4.2.13 Silt Fence Installation by Slicing Method \(p.374\)](#) for slicing method details. Silt fence installation using the slicing method specifications:
 1. The base of both end posts must be at least 2- to 4-inches above the top of the filter fabric on the middle posts for ditch checks to drain properly. Use a hand level or string level, if necessary, to mark base points before installation.
 2. Install posts 3- to 4-feet apart in critical retention areas and 6- to 7-feet apart in standard applications.
 3. Install posts 24-inches deep on the downstream side of the silt fence, and as close as possible to the filter fabric, enabling posts to support the filter fabric from upstream water pressure.
 4. Install posts with the nipples facing away from the filter fabric.

5. Attach the filter fabric to each post with three ties, all spaced within the top 8-inches of the filter fabric. Attach each tie diagonally 45 degrees through the filter fabric, with each puncture at least 1-inch vertically apart. Each tie should be positioned to hang on a post nipple when tightening to prevent sagging.
6. Wrap approximately 6-inches of fabric around the end posts and secure with 3 ties.
7. No more than 24-inches of a 36-inch filter fabric is allowed above ground level.

Compact the soil immediately next to the filter fabric with the front wheel of the tractor, skid steer, or roller exerting at least 60 pounds per square inch. Compact the upstream side first and then each side twice for a total of four trips. Check and correct the silt fence installation for any deviation before compaction. Use a flat-bladed shovel to tuck fabric deeper into the ground if necessary.

Figure II-4.2.13 Silt Fence Installation by Slicing Method

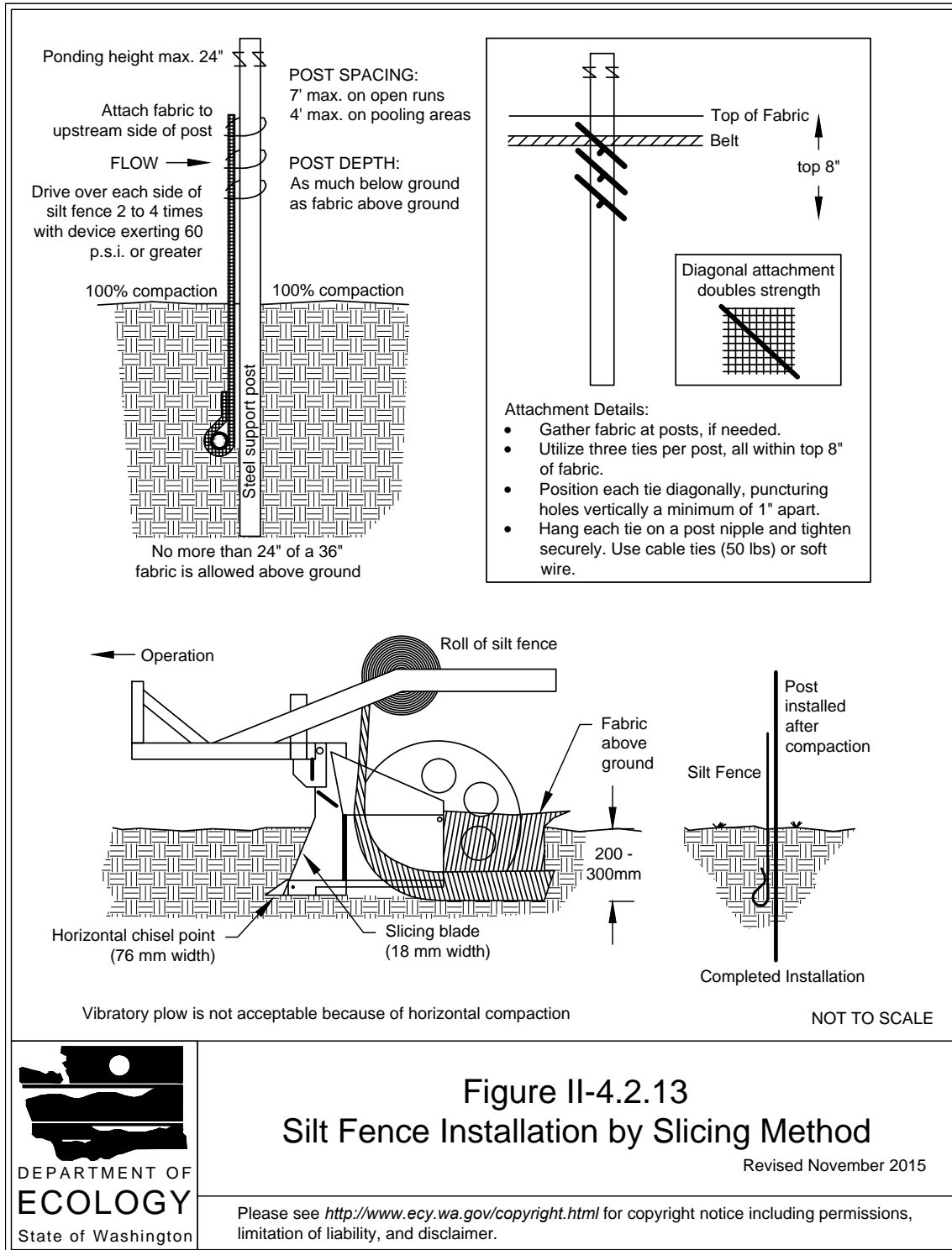

**Figure II-4.2.13
Silt Fence Installation by Slicing Method**

Revised November 2015

Please see <http://www.ecy.wa.gov/copyright.html> for copyright notice including permissions, limitation of liability, and disclaimer.

Maintenance Standards

- Repair any damage immediately.
- Intercept and convey all evident concentrated flows uphill of the silt fence to a sediment pond.
- Check the uphill side of the fence for signs of the fence clogging and acting as a barrier to flow and then causing channelization of flows parallel to the fence. If this occurs, replace the fence or remove the trapped sediment.
- Remove sediment deposits when the deposit reaches approximately one-third the height of the silt fence, or install a second silt fence.
- Replace filter fabric that has deteriorated due to ultraviolet breakdown.

BMP C241: Temporary Sediment Pond

Purpose

Sediment ponds remove sediment from runoff originating from disturbed areas of the site. Sediment ponds are typically designed to remove sediment no smaller than medium silt (0.02 mm). Consequently, they usually reduce turbidity only slightly.

Conditions of Use

Prior to leaving a construction site, stormwater runoff must pass through a sediment pond or other appropriate sediment removal best management practice.

A sediment pond shall be used where the contributing drainage area is 3 acres or more. Ponds must be used in conjunction with erosion control practices to reduce the amount of sediment flowing into the basin.

Design and Installation Specifications

- Sediment basins must be installed only on sites where failure of the structure would not result in loss of life, damage to homes or buildings, or interruption of use or service of public roads or utilities. Also, sediment traps and ponds are attractive to children and can be very dangerous. Compliance with local ordinances regarding health and safety must be addressed. If fencing of the pond is required, the type of fence and its location shall be shown on the ESC plan.
- Structures having a maximum storage capacity at the top of the dam of 10 acre-ft (435,600 ft³) or more are subject to the Washington Dam Safety Regulations ([Chapter 173-175 WAC](#)).
- See [Figure II-4.2.18 Sediment Pond Plan View \(p.391\)](#), [Figure II-4.2.19 Sediment Pond Cross Section \(p.392\)](#), and [Figure II-4.2.20 Sediment Pond Riser Detail \(p.393\)](#) for details.
- If permanent runoff control facilities are part of the project, they should be used for sediment retention. The surface area requirements of the sediment basin must be met. This may require temporarily enlarging the permanent basin to comply with the surface area requirements. The permanent control structure must be temporarily replaced with a control structure that only allows water to leave the pond from the surface or by pumping. The permanent control structure must be installed after the site is fully stabilized. .
- Use of infiltration facilities for sedimentation basins during construction tends to clog the soils and reduce their capacity to infiltrate. If infiltration facilities are to be used, the sides and bottom of the facility must only be rough excavated to a minimum of 2 feet above final grade. Final grading of the infiltration facility shall occur only when all contributing drainage areas are fully stabilized. The infiltration

pretreatment facility should be fully constructed and used with the sedimentation basin to help prevent clogging.

- Determining Pond Geometry

Obtain the discharge from the hydrologic calculations of the peak flow for the 2-year runoff event (Q_2). The 10-year peak flow shall be used if the project size, expected timing and duration of construction, or downstream conditions warrant a higher level of protection. If no hydrologic analysis is required, the Rational Method may be used.

Determine the required surface area at the top of the riser pipe with the equation:

$$SA = 2 \times Q_2 / 0.00096$$

or

2080 square feet per cfs of inflow

See [BMP C240: Sediment Trap \(p.383\)](#) for more information on the derivation of the surface area calculation.

The basic geometry of the pond can now be determined using the following design criteria:

- Required surface area SA (from Step 2 above) at top of riser.
- Minimum 3.5-foot depth from top of riser to bottom of pond.
- Maximum 3H:1V interior side slopes and maximum 2H:1V exterior slopes. The interior slopes can be increased to a maximum of 2H:1V if fencing is provided at or above the maximum water surface.
- One foot of freeboard between the top of the riser and the crest of the emergency spillway.
- Flat bottom.
- Minimum 1-foot deep spillway.
- Length-to-width ratio between 3:1 and 6:1.
- Sizing of Discharge Mechanisms.

The outlet for the basin consists of a combination of principal and emergency spillways. These outlets must pass the peak runoff expected from the contributing drainage area for a 100-year storm. If, due to site conditions and basin geometry, a separate emergency spill-way is not feasible, the principal spillway must pass the entire peak runoff expected from the 100-year storm. However, an attempt to provide a separate emergency spillway should always be made. The runoff calculations should be based on the site conditions during construction. The flow

through the dewatering orifice cannot be utilized when calculating the 100-year storm elevation because of its potential to become clogged; therefore, available spillway storage must begin at the principal spillway riser crest.

The principal spillway designed by the procedures contained in this standard will result in some reduction in the peak rate of runoff. However, the riser outlet design will not adequately control the basin discharge to the predevelopment discharge limitations as stated in [I-2.5.7 Minimum Requirement #7: Flow Control \(p.64\)](#).

However, if the basin for a permanent stormwater detention pond is used for a temporary sedimentation basin, the control structure for the permanent pond can be used to maintain predevelopment discharge limitations. The size of the basin, the expected life of the construction project, the anticipated downstream effects and the anticipated weather conditions during construction, should be considered to determine the need of additional discharge control. See [Figure II-4.2.21 Riser Inflow Curves \(p.394\)](#) for riser inflow curves.

Figure II-4.2.18 Sediment Pond Plan View

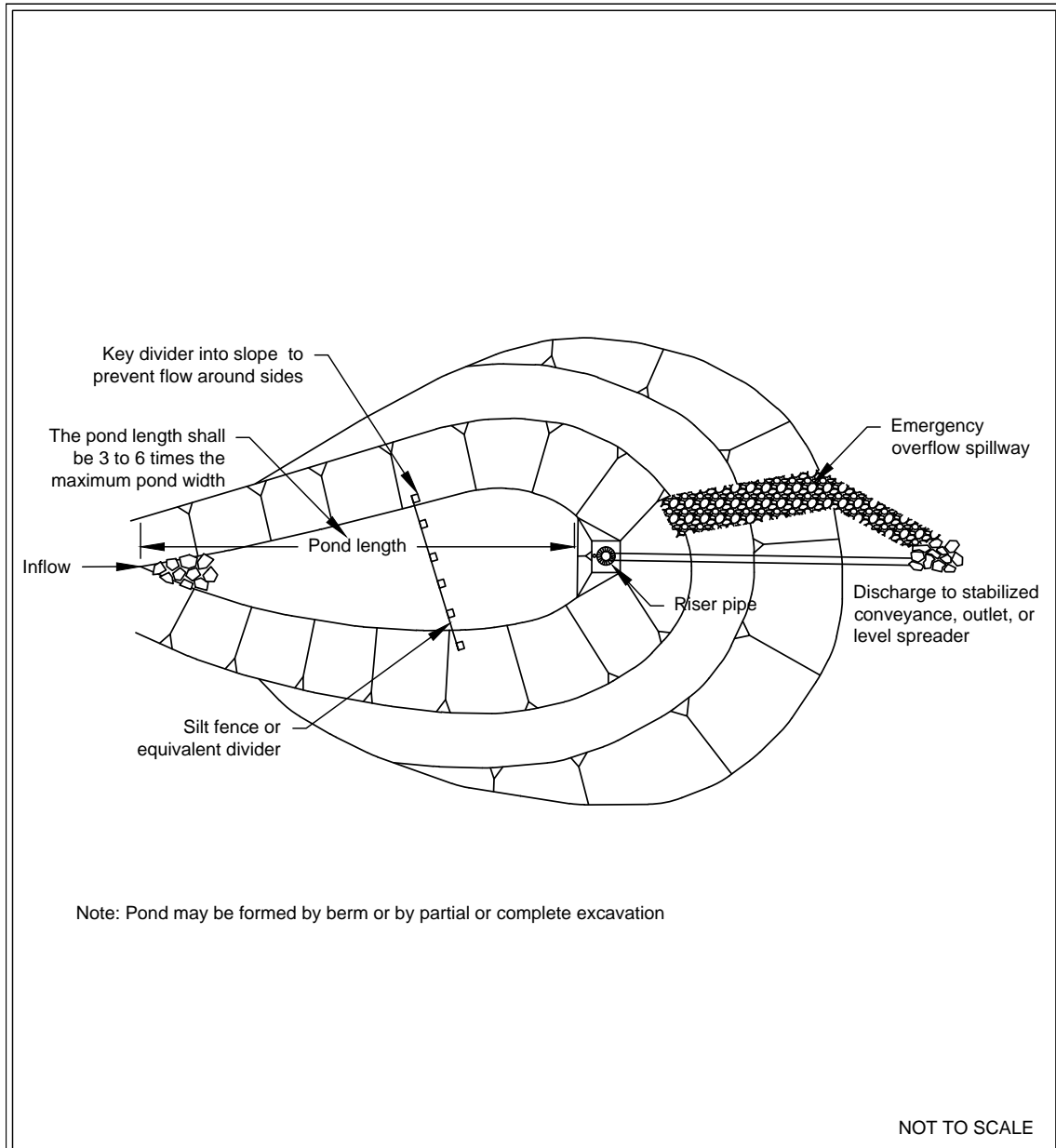
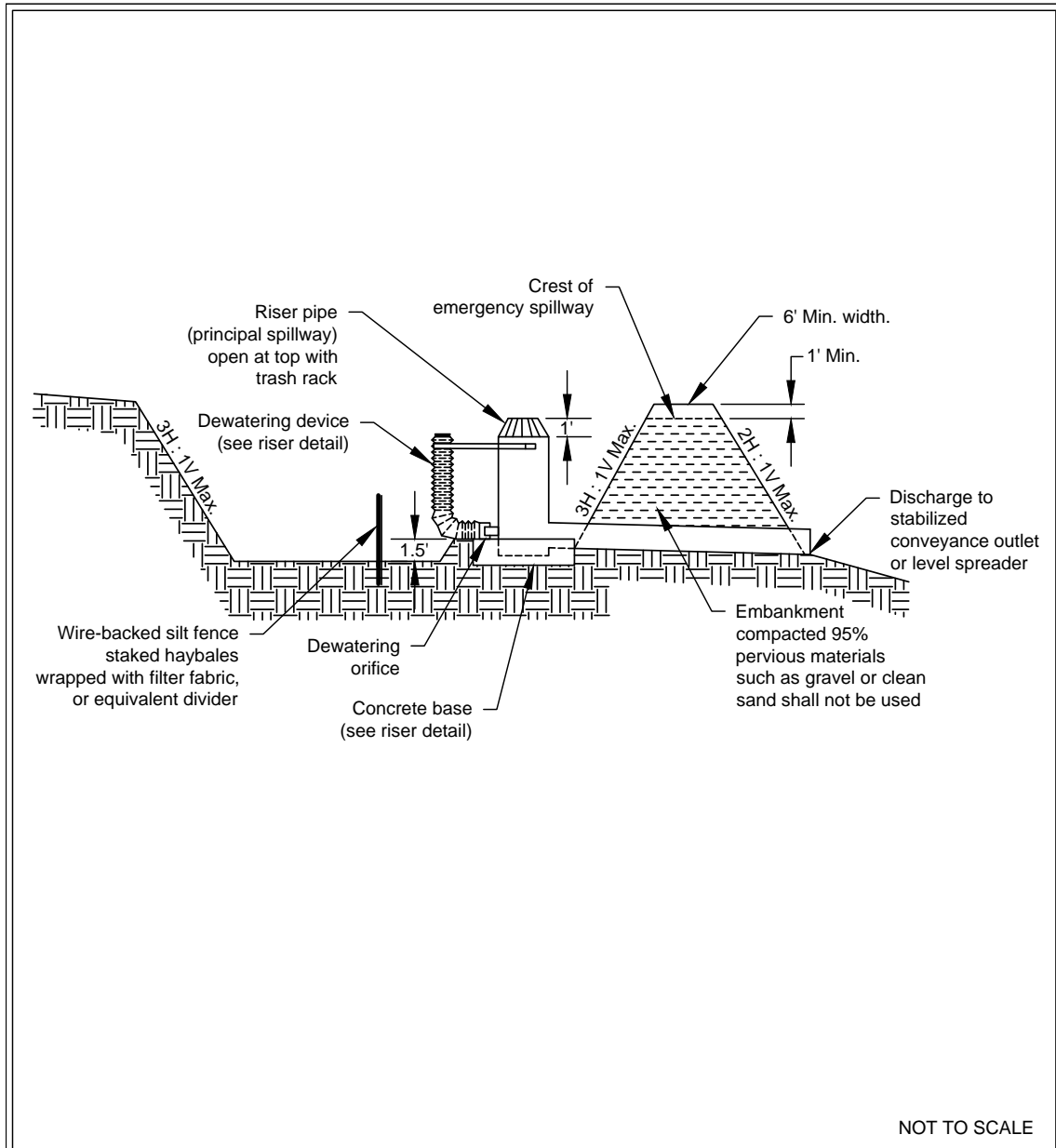

**Figure II-4.2.18
Sediment Pond Plan View**

Revised November 2015

Please see <http://www.ecy.wa.gov/copyright.html> for copyright notice including permissions, limitation of liability, and disclaimer.

Figure II-4.2.19 Sediment Pond Cross Section

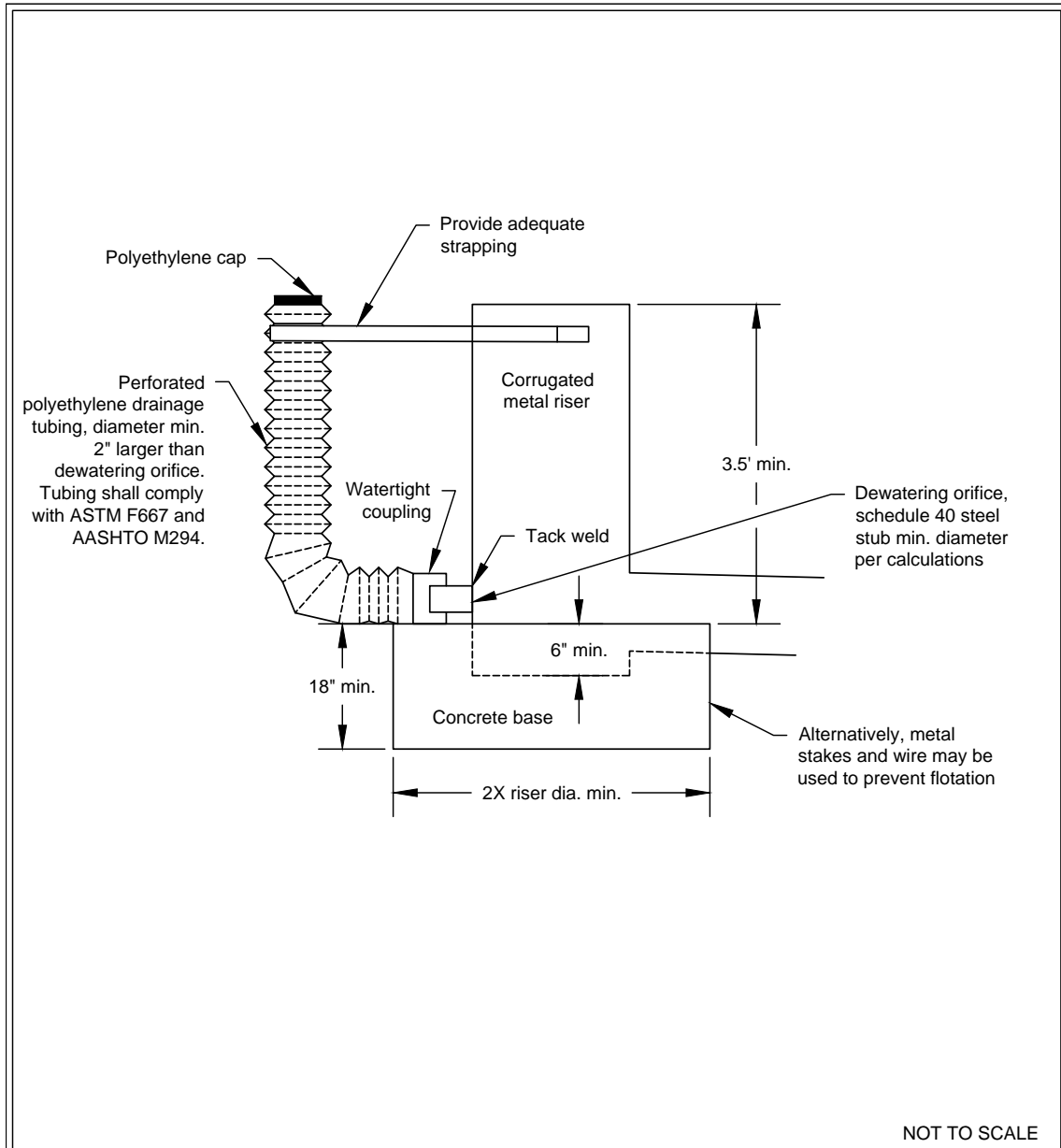

**Figure II-4.2.19
Sediment Pond Cross Section**

Revised November 2015

Please see <http://www.ecy.wa.gov/copyright.html> for copyright notice including permissions, limitation of liability, and disclaimer.

Figure II-4.2.20 Sediment Pond Riser Detail



**Figure II-4.2.20
Sediment Pond Riser Detail**

Revised November 2015

Please see <http://www.ecy.wa.gov/copyright.html> for copyright notice including permissions, limitation of liability, and disclaimer.

Figure II-4.2.21 Riser Inflow Curves

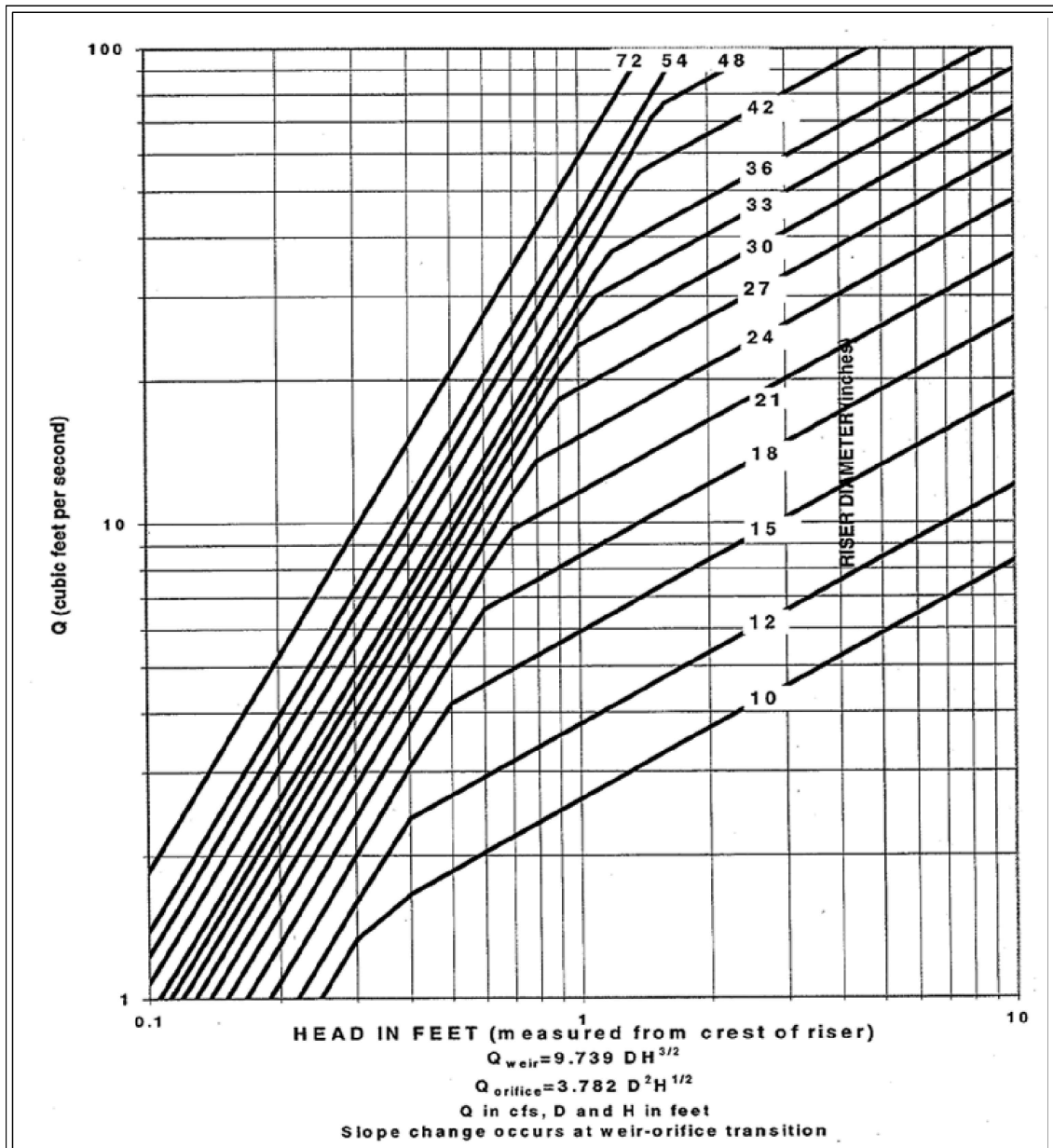

Figure II-4.2.21
Riser Inflow Curves

Revised November 2015

Please see <http://www.ecy.wa.gov/copyright.html> for copyright notice including permissions, limitation of liability, and disclaimer.

Principal Spillway: Determine the required diameter for the principal spillway (riser pipe). The diameter shall be the minimum necessary to pass the site's 15-minute, 10-year flowrate. If using the Western Washington Hydrology Model (WWHM), Version 2 or 3, design flow is the 10-year (1 hour) flow for the developed (unmitigated) site, multiplied by a factor of 1.6. Use [Figure II-4.2.21 Riser Inflow Curves \(p.394\)](#) to determine this diameter (h = 1-foot). *Note: A permanent control structure may be used instead of a temporary riser.*

Emergency Overflow Spillway: Determine the required size and design of the emergency overflow spillway for the developed 100-year peak flow using the method contained in Volume III.

Dewatering Orifice: Determine the size of the dewatering orifice(s) (minimum 1-inch diameter) using a modified version of the discharge equation for a vertical orifice and a basic equation for the area of a circular orifice. Determine the required area of the orifice with the following equation:

$$A_o = \frac{A_S(2h)^{0.5}}{0.6 \times 3600 T g^{0.5}}$$

where

A_o = orifice area (square feet)

A_S = pond surface area (square feet)

h = head of water above orifice (height of riser in feet)

T = dewatering time (24 hours)

g = acceleration of gravity (32.2 feet/second²)

Convert the required surface area to the required diameter D of the orifice:

$$D = 24 \times \sqrt{\frac{A_o}{\pi}} = 13.54 \times \sqrt{A_o}$$

The vertical, perforated tubing connected to the dewatering orifice must be at least 2 inches larger in diameter than the orifice to improve flow characteristics. The size and number of perforations in the tubing should be large enough so that the tubing does not restrict flow. The orifice should control the flow rate.

- Additional Design Specifications

The pond shall be divided into two roughly equal volume cells by a permeable divider that will reduce turbulence while allowing movement of water between cells. The divider shall be at least one-half the height of the riser and a minimum of one foot below the top of the riser. Wire-backed, 2- to 3-foot high, extra strength filter fabric supported by treated 4"x4"s can be used as a divider. Alternatively,

staked straw bales wrapped with filter fabric (geotextile) may be used. If the pond is more than 6 feet deep, a different mechanism must be proposed. A riprap embankment is one acceptable method of separation for deeper ponds. Other designs that satisfy the intent of this provision are allowed as long as the divider is permeable, structurally sound, and designed to prevent erosion under or around the barrier.

To aid in determining sediment depth, one-foot intervals shall be prominently marked on the riser.

If an embankment of more than 6 feet is proposed, the pond must comply with the criteria contained in [Volume III \(p.423\)](#) regarding dam safety for detention BMPs.

- The most common structural failure of sedimentation basins is caused by piping. Piping refers to two phenomena: (1) water seeping through fine-grained soil, eroding the soil grain by grain and forming pipes or tunnels; and, (2) water under pressure flowing upward through a granular soil with a head of sufficient magnitude to cause soil grains to lose contact and capability for support.

The most critical construction sequences to prevent piping will be:

1. Tight connections between riser and barrel and other pipe connections.
2. Adequate anchoring of riser.
3. Proper soil compaction of the embankment and riser footing.
4. Proper construction of anti-seep devices.

Maintenance Standards

- Sediment shall be removed from the pond when it reaches 1-foot in depth.
- Any damage to the pond embankments or slopes shall be repaired.

Alternative BMPs

The following are possible alternative BMPs for each of the 12 elements not described in Appendix B. This list can be referenced in the event a BMP for a specific element is not functioning as designed and an alternative BMP needs to be implemented. There are no alternatives listed at this time. Alternative BMPs can be added as warranted during construction.

Grass Lined Channels (BMP C201)

Correspondence

There are no correspondence documents at this time.



Site Inspection Form

Site Inspection Form

General Information

Project Name:

Inspector Name:

Date:

Title:

CESCL # :

Time:

- Inspection Type:
- After a rain event
 - Weekly
 - Turbidity/transparency benchmark exceedance
 - Other

Weather

Precipitation

Since last inspection

In last 24 hours

Description of General Site Conditions:

Inspection of BMPs

Element 1: Mark Clearing Limits

BMP:

Location	Inspected		Functioning			Problem/Corrective Action
	Y	N	Y	N	NIP	

BMP:

Location	Inspected		Functioning			Problem/Corrective Action
	Y	N	Y	N	NIP	

Element 2: Establish Construction Access

BMP:

Location	Inspected		Functioning			Problem/Corrective Action
	Y	N	Y	N	NIP	

BMP:

Location	Inspected		Functioning			Problem/Corrective Action
	Y	N	Y	N	NIP	

Element 3: Control Flow Rates

BMP:

Location	Inspected		Functioning			Problem/Corrective Action
	Y	N	Y	N	NIP	

BMP:

Location	Inspected		Functioning			Problem/Corrective Action
	Y	N	Y	N	NIP	

Element 4: Install Sediment Controls

BMP:

Location	Inspected		Functioning			Problem/Corrective Action
	Y	N	Y	N	NIP	

BMP:

Location	Inspected		Functioning			Problem/Corrective Action
	Y	N	Y	N	NIP	

BMP:

Location	Inspected		Functioning			Problem/Corrective Action
	Y	N	Y	N	NIP	

BMP:

Location	Inspected		Functioning			Problem/Corrective Action
	Y	N	Y	N	NIP	

BMP:

Location	Inspected		Functioning			Problem/Corrective Action
	Y	N	Y	N	NIP	

Element 5: Stabilize Soils

BMP:

Location	Inspected		Functioning			Problem/Corrective Action
	Y	N	Y	N	NIP	

BMP:

Location	Inspected		Functioning			Problem/Corrective Action
	Y	N	Y	N	NIP	

BMP:

Location	Inspected		Functioning			Problem/Corrective Action
	Y	N	Y	N	NIP	

BMP:

Location	Inspected		Functioning			Problem/Corrective Action
	Y	N	Y	N	NIP	

Element 6: Protect Slopes

BMP:

Location	Inspected		Functioning			Problem/Corrective Action
	Y	N	Y	N	NIP	

BMP:

Location	Inspected		Functioning			Problem/Corrective Action
	Y	N	Y	N	NIP	

BMP:

Location	Inspected		Functioning			Problem/Corrective Action
	Y	N	Y	N	NIP	

Element 7: Protect Drain Inlets

BMP:

Location	Inspected		Functioning			Problem/Corrective Action
	Y	N	Y	N	NIP	

BMP:

Location	Inspected		Functioning			Problem/Corrective Action
	Y	N	Y	N	NIP	

BMP:

Location	Inspected		Functioning			Problem/Corrective Action
	Y	N	Y	N	NIP	

Element 8: Stabilize Channels and Outlets

BMP:

Location	Inspected		Functioning			Problem/Corrective Action
	Y	N	Y	N	NIP	

BMP:

Location	Inspected		Functioning			Problem/Corrective Action
	Y	N	Y	N	NIP	

BMP:

Location	Inspected		Functioning			Problem/Corrective Action
	Y	N	Y	N	NIP	

BMP:

Location	Inspected		Functioning			Problem/Corrective Action
	Y	N	Y	N	NIP	

Element 9: Control Pollutants

BMP:

Location	Inspected		Functioning			Problem/Corrective Action
	Y	N	Y	N	NIP	

BMP:

Location	Inspected		Functioning			Problem/Corrective Action
	Y	N	Y	N	NIP	

Element 10: Control Dewatering

BMP:

Location	Inspected		Functioning			Problem/Corrective Action
	Y	N	Y	N	NIP	

BMP:

Location	Inspected		Functioning			Problem/Corrective Action
	Y	N	Y	N	NIP	

BMP:

Location	Inspected		Functioning			Problem/Corrective Action
	Y	N	Y	N	NIP	

Stormwater Discharges From the Site

Location	Observed?		Problem/Corrective Action
	Y	N	
Turbidity			
Discoloration			
Sheen			
Turbidity			
Discoloration			
Sheen			

Water Quality Monitoring	
Was any water quality monitoring conducted?	<input type="checkbox"/> Yes <input type="checkbox"/> No
If water quality monitoring was conducted, record results here:	
If water quality monitoring indicated turbidity 250 NTU or greater; or transparency 6 cm or less, was Ecology notified by phone within 24 hrs?	
	<input type="checkbox"/> Yes <input type="checkbox"/> No
If Ecology was notified, indicate the date, time, contact name and phone number below:	
Date:	
Time:	
Contact Name:	
Phone #:	
General Comments and Notes	
Include BMP repairs, maintenance, or installations made as a result of the inspection.	
Were Photos Taken?	<input type="checkbox"/> Yes <input type="checkbox"/> No
If photos taken, describe photos below:	

Construction Stormwater General Permit (CSWGP)

The Construction Stormwater General Permit will be inserted once it has been granted approval by the Department of Ecology.



303(d) List Waterbodies / TMDL Waterbodies Information

Below are the details for 303(d) listings taken from the Washington State DOE website.



Contaminated Site Information

There are no known contaminated soils onsite at this time.



Engineering Calculations

